



medi

medi product catalogue

Lymphology
Valid from April 2015

medi. I feel better.

medi's world of compression

medi thinks compression right through to the end. Therefore, you can rely on medi products. They are produced for maximum compliance to guarantee the best possible treatment success.

To introduce you to medi's world of compression we created indication related catalogues. This enables you to find the correct product for all the different indications and situations in no time. Please find a short explanation of the different literature below:



Venous Health

mediven compression stockings are the ideal introduction to the world of healthy venous living. They are the best form of therapy for patients with venous disorders. Discover more about the numerous styles and variants of mediven and circaid products for venous health.

Art. no.: 97D67



Lymphatic Diseases

Flat knitted compression stockings are used for lip and lymphoedema. They help to keep the oedema constant after decongestion, as well as to further optimise the results. medi offers different mediven and circaid qualities with functional characteristics, according to the respective indications and the patient's needs.

Art. no.: 97D66



Wound Care

With mediven ulcer kit and circaid juxtacures medi offers two innovative products for the effective treatment of acute crural ulcers. For the prevention of recurrence medi also has a lot of solutions for each individual patient.

Art. no.: 97D68



Clinical Compression

The world of Clinical Compression is more than just thrombosis prophylaxis in the clinical environment. Learn more about the multiple application fields of medi's hospital products and benefit from over 40 years of experience with Clinical Compression.

Art. no.: 99580





medi

medi produces medical aids for a variety of conditions and life situations. But we don't see ourselves solely as a manufacturer. On the contrary, we handle our own research and development, technology, production, and marketing and sales in-house – always keeping our focus on the market, its demands and variables, and the medi vision.

We have the direct connection

To communicate. To co-operate. To be there for each other. The medi service team respects and values this requirement seriously.

Therefore, our office not only offers consultants, but also a state-of-the art communications system and logistics.

Just-in-time: in consultancy, in service, in ordering and delivery.

We are always here for you.

This is your medi export service team.

Hotline

for consultancy, ordering, problem solutions

Administration

T +49 921 912 -0

F +49 921 912 -781

You can visit our website:	www.medi.de/en
or contact us by email:	export@medi.de
or order by email:	orders@medi.de



4

General

- 8 More than just a manufacturer
- 9 Quality Certificates
- 10 Treatment concept
- 12 Indication overview – elastic and inelastic compression

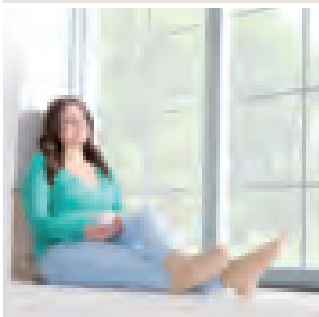

14

mediven®

Elastic compression

Leg garments

- 18 Quality overview and application

Leg garments – Flat knit

- 20 mediven 550 leg and toe cap
- 26 mediven mondi and toe cap
- 32 mediven sensoo

Leg garments – Round knit

- 36 mediven forte
- 40 mediven plus

Arm garments

- 44 Quality overview and application

Arm garments – Flat knit

- 46 mediven 550 arm
- 50 mediven esprit

Arm garments – Round knit

- 54 mediven harmony

Genital treatment

- 60 Whitaker Pouch



62

Commercial products

- 64 Donning and doffing aids
- 68 Skin care
- 73 Textile care
- 76 medi Lymphpads

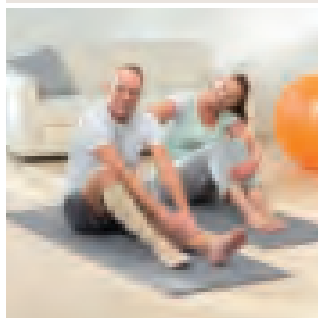

78

circaid®

Inelastic compression

- 82 Product benefits and icons
- 83 Patented technology
- 84 circaid juxtafit premium leg garments
- 88 circaid juxtafit essentials leg garments
- 92 circaid foot options
- 96 circaid juxtafit essentials arm
- 100 circaid juxtafit essentials hand options
- 102 circaid accessories and further products
- 108 What is included in your order?



110

Service

Measuring & order forms

More than just a manufacturer

medi produces medical aids for a variety of conditions and life situations. But we don't see ourselves solely as a manufacturer. On the contrary, we handle our own research and development, technology, production, marketing and sales in-house – always keeping our focus on the market, its demands and variables, and the medi vision.

Within its four business divisions, Phlebology, Orthopaedics, Prosthetics and Hospital, medi offers products in four business divisions: Phlebology, Hospital, Orthopaedics and Prosthetics. These products are used and distributed by medical supply stores, hospitals and clinics, doctors' practices and therapists. In other words, specialists who know which aids to improve their quality of life.

What we're proud of and what makes our products so special is that they're all completely free of negative side effects.

Our range of products primarily includes medical compression stockings for people with vein disorders, lipoedema and lymphoedema, supports and braces for the conservative and post-operative treatment of orthopaedic injuries and disorders, stockings for the prevention of thrombosis, anti-embolism stockings for use after vein surgery, compression garments for use after plastic and cosmetic surgery plus a variety of therapy-supporting products.

We support our partners in the sale and supply of our products and have developed intelligent concepts and services for this purpose.

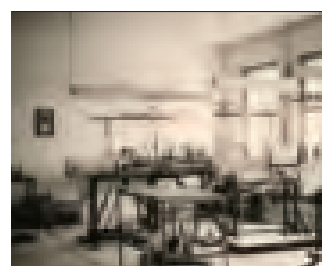
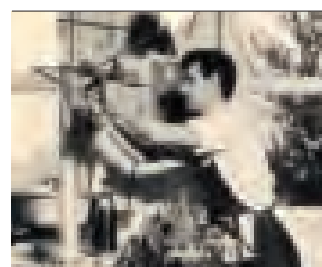

Quality Certificates

As a manufacturer of medical products, medi has a high awareness for quality. Product and system certificates prove that all legal requirements are met.

CE mark

Our medi medical products meet all of the requirements of the European Directive 93 / 42 / EEC and of the German Medical Devices Act. In accordance with regulations, our products are subject to the conformity assessment procedures and are granted the CE mark. As a kind of “passport for industrial products”, the CE mark guarantees free trade within the European Economic Area (EEA).



Quality label

Our medical compression hosiery is regularly checked by the Hohenstein Research Institute according to the quality and test provisions of the RAL-GZ 387. As confirmation that our products meet the quality conditions, you will find the quality label printed on the packaging.

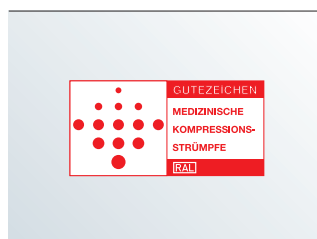

Textile trust quality seal

All compression stockings and garments, whether circular-knit or flat-knit, thrombosis prophylaxis stockings and supports are regularly examined and rated according to strict standards by independent test centres for any toxic substances potentially damaging to human health. Granting of the Oeko-Tex Standard 100 certificate guarantees: tested quality for the protection of your health.

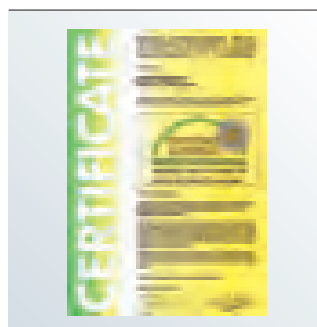

DIN EN ISO 9001 : 2000 / DIN EN 13485

medi maintains the quality management system according to DIN EN ISO 9001 : 2000 and DIN EN 13485. Since 1996, we have demonstrated our ISO 9000 status to our customers with a certificate. From this time, medi has exploited the opportunities offered by this standard to continually improve products from the business units Phlebology, Orthotics, Prosthetics and Hospital in order to organise safer and more efficient processes and procedures. We define customer satisfaction as a decisive measure of quality.

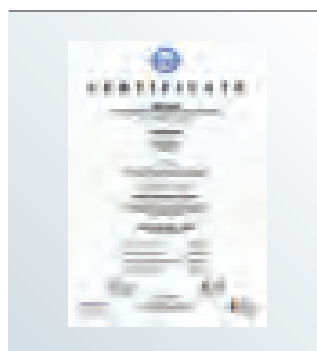

Hohenstein testing device – HOSY

Pressure is the most important feature of a medical compression stocking.

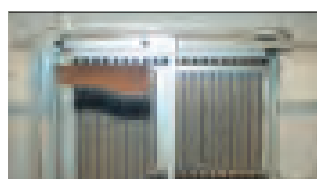

Treatment concept for highest possible compliance



Medical professional care

Phase 1

Medical professional care

Medical professional care is the treatment or management of venous and/or lymphatic diseases involving a trained clinical practitioner. Products are provided, applied and managed by a physician, therapist or nurse.

Self care



Elastic compression garments
Inelastic compression garments

- ▶ **mediven®**
flat-knitted garments
(according to indication)
- ▶ **mediven®**
round-knitted garments
(according to indication)
- ▶ **circaid®**
inelastic garments
(according to indication)

Self care

I feel better.

Phase 2

Self care

Self care means the ongoing management of venous and/or lymphatic diseases by the patient.
The provided medical compression products are applied and managed by the patient.

Indication overview – lower limbs

Diagnosis	Primary symptom		Elastic				Inelastic		
			mediven 550 leg	mediven mondi *	mediven sensoo*	mediven forte*	circaid juxtafit premium	circaid juxtafit essentials	circaid graduate leg
			for connective tissues · soft · normal · firm	for connective tissues · normal · firm	for connective tissues · normal	for connective tissues · normal	for connective tissues · soft · normal · firm	for connective tissues · soft · normal · firm	for connective tissues · soft · normal · firm
Stage 1	Spontaneously reversible, soft and doughy swelling, pitting on pressure, no skin changes	AD AG AT	CCL 2	CCL 2	CCL 2	(CCL 2) (CCL 3)	mmHg **	mmHg **	mmHg **
Stage 2	Spontaneously reversible, early fibrosis, pitting hardly possible, sometimes skin changes	AD AG AT	CCL 2 CCL 3	CCL 2 CCL 3			mmHg **	mmHg **	mmHg **
Stage 3	Pronounced form, elephantiasis, fibrosis, typical chronic skin changes	AD AG AT	CCL 2 CCL 3 CCL 4				mmHg **	mmHg **	mmHg **

Caution

mediven mondi and mediven 550 leg, compression class 1, are indicated for the following comorbidities or accompanying conditions:

- arterial circulatory disorders
- paralysis
- after bypass surgery
- after stroke
- for joint problems
- when treating children

The corresponding reason must be noted on the prescription.

Explanation

* Please remember that mediven mondi, mediven sensoo and mediven forte models are for mild to moderate indications.

They do not have sufficient wall stability to model the tissues in patients with very lax connective tissue. They cut into skin folds and cause constriction.

** Please adjust as prescribed.

Indication overview – upper limbs

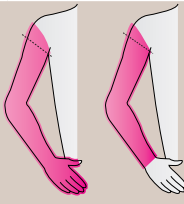
				Inelastic				
Diagnosis	Primary symptom			mediven 550 arm	mediven esprit *	mediven harmony*	circaid juxtafit essentials	circaid graduate arm
				connective tissue • soft • normal • firm	connective tissue • normal • firm	connective tissue • firm	connective tissue • soft • normal • firm	connective tissue • soft • normal • firm
Stage 1	Spontaneously reversible, soft and doughy swelling, pitting on pressure, no skin changes	AG	CG	CCL 1 CCL 2	CCL 1	CCL 2	mmHg **	mmHg **
Stage 2	Spontaneously reversible, early fibrosis, pitting hardly possible, sometimes skin changes	AG	CG	CCL 2	CCL 2		mmHg **	mmHg **
Stage 3	Pronounced form, elephantiasis, fibrosis, typical chronic skin changes	AG	CG	CCL 2 CCL 3			mmHg **	mmHg **

Explanation of compression classes	
CCL 1	Compression in mmHg 18.0 – 21.0 Compression in kPa 2.40 – 2.80
CCL 2	Compression in mmHg 23.0 – 32.0 Compression in kPa 3.10 – 4.30
CCL 3	Compression in mmHg 34.0 – 46.0 Compression in kPa 4.50 – 6.10
CCL 4	Compression in mmHg mind. 49.0 Compression in kPa mind. 6.50

Please note

mediven 550 arm in compression class I is indicated for the following comorbidities or accompanying conditions:

- arterial circulatory disorders
- for paralysis
- after bypass surgery
- after a stroke
- for joint problems
- when treating children

Explanation

* Please remember that mediven esprit and mediven harmony are garments for mild indications.

It does not have sufficient wall stability to model the tissues in patients with very lax connective tissue. It cuts into skin folds and causes constriction.

** Please adjust as prescribed.





mediven® Elastic compression

Simply feel good.

Flat knitted compression stockings are used for lip and lymphoedema. They help to keep the oedema constant after decongestion, as well as to further optimise the results. medi offers different qualities with functional characteristics, according to the respective indications. For example breathable material results in a high wearing comfort.



There are many reasons for deciding for mediven®

These powerful product features speak for themselves.



High treatment compliance with medi

The medi compression seal of quality marks highly effective compression treatment. It stands for premium products based on 60 years of experience in research and development. The technology with the defined compression gradient promotes the flow of venous blood back to the heart and reliably activates the lymphatic system. The result: pain and swelling are relieved and your clients feel fitter and more active. medi compression-quality made in Germany.



Anatomical oblique borders as standard (distal and proximal)

- Unimpeded lymphatic drainage without circular constriction
- Optimum fit and better hold

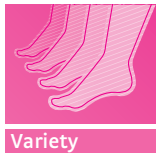

Special measurements to fit personal needs

- Individual made-to-measure garments for severe indications, unusual limb shapes or for special characteristics



Clima Comfort®* for perfect climate exchange

- Well-being all year round
- Highly active breathing
- Prevents itch

*Clima Comfort®

Comfort, scientifically tested by the French Institute IFTH. The test result shows that the Clima Comfort technology from medi guarantees climate exchange between the skin and the stocking. medi achieved an outstanding total score of 11 out of 12 points.



Clima Fresh for more freshness for the whole leg

- Antibacterial effect in the knit
- Binds odours
- Special spinning technique that guarantees the effect, even after washing



Perfect Fit

- Very precise compression dosing
- Optimum medical care conditions

Power yarn for pressure over an area

- Deep acting pressure over larger areas
- More stable and less elastic for effective treatment of oedema
- Optimum pressure stability, all day long

Flat seam with elastic seam tape

- Resistant to chafing and wear-and-tear
- For more freedom of movement

Easy to care for

- Suitable for the delicates programme of washing machines and tumble driers



Very good skin tolerability and suitability for everyday wear

- Without cotton or rubber



Lymphology

The mediven high-quality flat knit range offers you clear advantages.

mediven stockings are available in different qualities and variants. The unique feature: They are obtainable in attractive colours and patterns. Lymph patients hereby profit due to optimal care and they also have the option of combining the stockings with their wardrobe.

By the way, aside from stockings, medi also offers toe caps in different styles and colours. Perfect patient care by medi – all the way to the tips of the toes.

Score points with the following advantages:

- Customer loyalty by offering an individual choice of products and a high number of variants. You are able to provide each of your customers with a product that is suitable for his / her indication.
- Win new customers with competent advice. You can be confident in advising your customers individually and correctly with the mediven flat knit products.
- High customer satisfaction and better compliance due to the high-quality finish and the potential for providing individual care with mediven products. Secure your share of success as part of the holistic therapy concept.
- Ease of handling and basic product knowledge will ensure confidence when dealing with customers.

Leg garment	Oedema stage	Knitting technique	S = Standard M = Made-to-measure	Page
mediven 550 leg	1, 2, 3	flat knit	S, M	20
mediven mondi	1, 2	flat knit	S, M	26
mediven sensoo	1	flat knit	M	32
mediven forte	1	round knit	S, M	36
mediven plus	1	round knit	S, M	40



mediven® 550 leg

Highest wall stability and unlimited variety – for oedema up to stage 3.

Indications

- Primary and secondary lymphoedema stages 1, 2 and 3
- Lipoedema stages 1, 2 and 3
- Elephantiasis
- Severe phlebological conditions with a tendency to develop oedema
- Keloid treatment, e. g. after burns
- Post-operative and post-traumatic oedema
- Mixed forms such as phlebolymphoedema, lipolymphoedema

Consistency of the connective tissues

Recommended for soft to firm connective tissues.

Product features

- Highest working pressure
- Over 5,600 combination options with special extras such as soft toe
- Numerous variants such as leg sections for double and multipart garments
- Fashionable variety: 3 standard colours, 7 trend colours and 3 unique design elements

Best of all:
the trend colours and
design elements are
available at no extra
charge.

Design elements



Stars



Ribbs

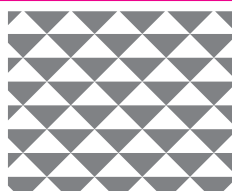

Pyramids

The design elements can be freely combined with the standard and trend colours.

Compression

CCL 1, 2, 3, 4

Product benefits



Clima Comfort



Clima Fresh



Perfect Fit



Variety



Anatomic Fit



Colours

S = Standard

M = Made-to-measure

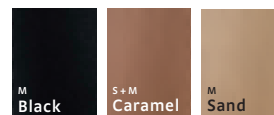

Standard colours

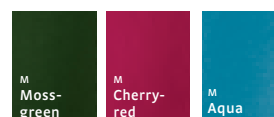
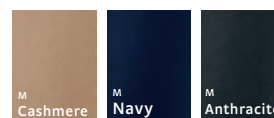

Trend colours

Delivery period up to 10 working days.

mediven® 550 leg made-to-measure

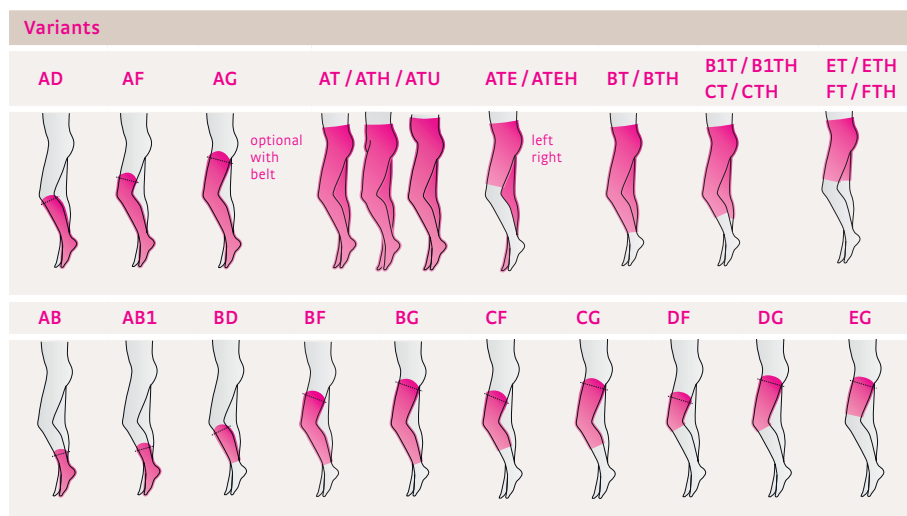

Standard models	
Border	Flat oblique with all stocking variants
Styles	Flat oblique at the thigh and perforated topband with all pantyhose variants
Gusset	Men's gusset: ATH, ATEH, FTH, ETH, CTH, BTH non-compressive front panty top: ATU, ATEU, FTU, ETU, CTU, BTU
Foot	Oblique, open foot

	Material composition	
	Elastane (EL)	Polyamide (PA)
CCL 1	23 %	77 %
CCL 2	25 %	75 %
CCL 3	28 %	72 %
CCL 4	32 %	68 %

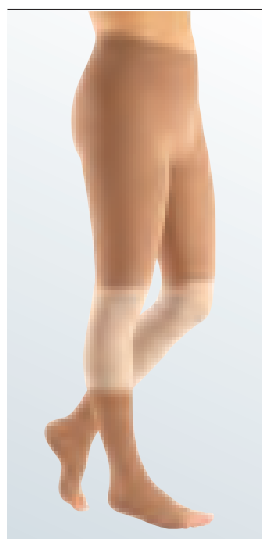

Combination of below knee stocking, capri panty and cycling shorts

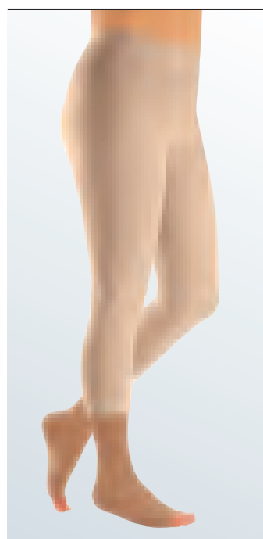

Combination of below knee stocking and CT leg section

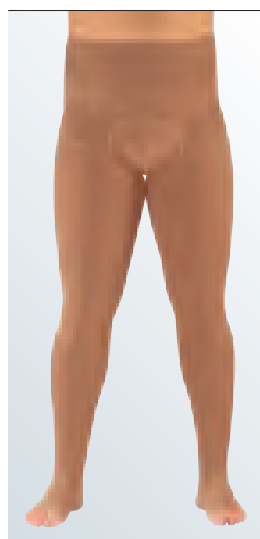

Men's leotard



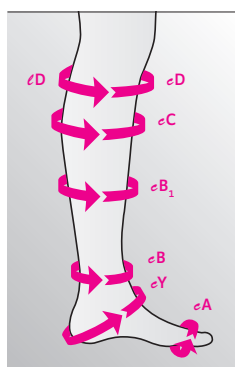

One-legged pantyhose

mediven® 550 leg ready-to-wear



l = length measurements
e = circumferences

Variants		
Styles	AD	AD pte.
		
	calf	calf petite
Article No.	B2407*	B2477*
	*add size number 04 – 14	

CCL	2
Length	2 lengths for AD / calf and AD / calf petite
Foot	Open toe straight ending
Topband	Profile topband
Standard sizes	IV – XIV
Colour	Caramel

Circumference in cm											
Standard size	IV	V	VI	VII	VIII	IX	X	XI	XII	XIII	XIV
eD	29 – 33	30 – 34	31 – 35	32 – 36	33 – 37	34 – 38	35 – 39	36 – 40	37 – 41	38 – 42	39 – 43
eC	30 – 34	31 – 35	32 – 36	33 – 37	34 – 38	35 – 39	36 – 40	37 – 41	38 – 42	39 – 43	40 – 44
eB ₁	24 – 26	25 – 27	26 – 28	27 – 29	28 – 30	29 – 32	29 – 33	30 – 34	31 – 35	32 – 36	33 – 37
eB	19 – 20	20 – 21	21 – 22	22 – 23	23 – 24	24 – 25	25 – 26	26 – 27	27 – 28	28 – 29	29 – 30
eY	27 – 29	28 – 30	29 – 32	29 – 33	30 – 34	31 – 35	32 – 36	33 – 37	34 – 38	35 – 39	36 – 40
eA	18 – 20	19 – 21	20 – 22	21 – 23	22 – 24	23 – 25	24 – 26	25 – 27	26 – 28	27 – 29	28 – 30
Length measurements in cm											
	lD normal 39 – 41					lD short 37 – 39					



mediven[®] 550 toe cap

Highest wall stability and unlimited variety – for oedema up to stage 3.

Indications

- Lymphoedema of the forefoot and toes
- Lymphoedema of the dorsum of the foot

Product features

- Toe cap with Clima Fresh: reliably prevents odour and colonisation by bacteria
- Unique top and bottom principle:
 - Seams moved to the upper and lower surfaces of the toes in the direction of lymphatic drainage
 - Lateral seams give every toe stability for an effective action
 - Each single toe made to measure anatomically for an optimum fit
- Optional integration of medi lymphpads for additional pressure in lymphoedema of the dorsum of the foot

Seamless toe cap

- More reliable measurements (no longer necessary to calculate the overlap)
- Care to suit the indication for optimum lymphatic drainage (no circular seams)
- Very comfortable to wear, without circular seams
- Outstanding non-slip grip
- Available in variants AD and AG



Seamless toe cap

Individual toe cap

- Increased wall stability due to double compression garments for pronounced forms of oedema over the dorsum of the foot
- Increased treatment compliance due to quick and easy donning
- Individual care options, e.g. nightwear or combination with other product variants



Individual toe cap

Seamed toe cap

- Individual care possible if different compression classes are needed for the leg and toes
- Outstanding non-slip grip



Seamed toe cap

Versions available

Closed toe cap



Closed toe cap without small toe



Open toe cap



Open toe cap without small toe



Compression

CCL 1, 2, 3

Product benefits



Clima Comfort



Clima Fresh



Perfect Fit



Variety



Anatomic Fit



Colours

M = Made-to-measure

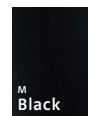

M Black



M Caramel



M Sand



M Cashmere



M Navy

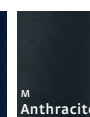

M Anthracite

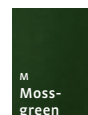

M Moss-green



M Cherry-red



M Aqua



M medi Magenta

Design Elements



Stars



Ribs



Pyramids



Comfortable and effective – for oedema up to stage 2.

Indications

- Primary and secondary lymphoedema stages 1 and 2
- Lipoedema stages 1 and 2
- Post-operative and post-traumatic oedema
- Severe phlebological conditions with a tendency to develop oedema
- Keloid treatment, e. g. after burns

Consistency of the connective tissues

Recommended for normal to firm connective tissue.

Product features

- Available with silver segments:
 - Y-C, Y-D, Y-G
 - Antibacterial effect for patients with e.g. chronic wounds, atopic dermatitis
 - Segments provide for specific and cost-effective use
- Supple knit
- Many combination options with special extras such as Y-knitting marks
- Fashionable variety: 3 standard colours and 7 trend colours

Compression

CCL 1, 2, 3

Product benefits



Clima Comfort



Clima Fresh



Perfect Fit



Variety



Anatomic Fit



Colours

S = Standard

M = Made-to-measure

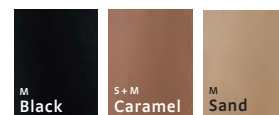

Standard colours

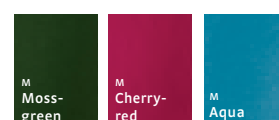
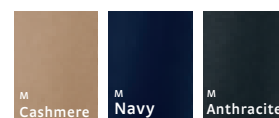

Trend colours

Delivery period up to 10 working days.

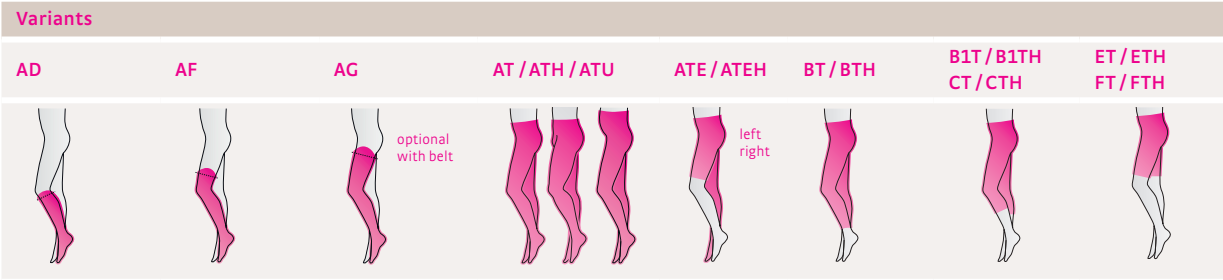

Standard models

Border	Flat oblique with all stocking variants
Style	Flat oblique at the thigh and perforated topband with all pantyhose variants
Gusset	Men's gusset: ATH, ATEH, FTH, ETH, CTH, BTH non-compressive front panty top: ATU, ATEU, FTU, ETU, CTU, BTU
Foot part	Oblique, open foot

Material composition

	Elastane (EL)	Polyamide (PA)
CCL 1	22 %	78 %
CCL 2	24 %	76 %
CCL 3	28 %	72 %

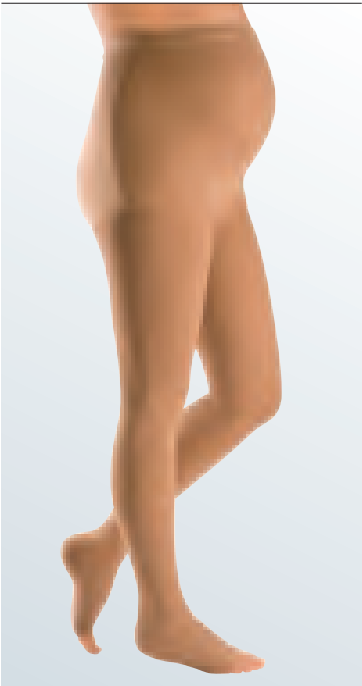

Maternity panty



Thigh-length stocking with open toe



Below knee stocking with open toe

mediven mondi® ready-to-wear

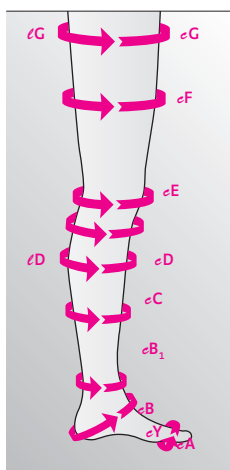

l = length measurements
e = circumferences

Variants				
Styles	AD	AD pte.	AG / PrB	AG pte. / PrB
	calf	calf petite	thigh with topband	thigh petite with topband
Article No.	C2407*	C2477*	C26P7*	C25P7*
	*add size number 01 – 07			
CCL	2			
Length	2 lengths for AD / calf and AG / thigh			
Foot	Open toe straight ending			
Topband	Profile topband			
Standard sizes	I – VII			
Colour	Caramel			

Circumference in cm

Standard size	eG	eF	eE	eD	eC	eB ₁	eB	eY	eA
I	44 – 53	40 – 47	30 – 37	28 – 33	29 – 34	24 – 26	18 – 20	28 – 30	18 – 21
II	46 – 57	42 – 51	33 – 40	30 – 35	31 – 36	26 – 28	20 – 22	29 – 32	20 – 23
III	50 – 61	45 – 55	36 – 42	32 – 37	33 – 38	28 – 31	22 – 24	31 – 34	22 – 25
IV	53 – 65	48 – 58	38 – 44	34 – 39	35 – 40	30 – 33	24 – 26	33 – 36	24 – 27
V	56 – 70	51 – 62	40 – 46	36 – 41	37 – 42	32 – 35	26 – 28	34 – 38	26 – 29
VI	60 – 74	54 – 67	42 – 48	38 – 43	39 – 44	34 – 37	28 – 30	36 – 40	28 – 31
VII	64 – 80	58 – 72	44 – 50	40 – 45	41 – 46	36 – 39	30 – 32	37 – 41	30 – 33

Length measurements in cm

AD standard	38 – 43	AG standard	72 – 83
AD short	33 – 37	AG short	62 – 71



mediven mondi® toe cap

Comfortable and effective – for oedema up to stage 2.

Indications

- Lymphoedema of the forefoot and toes
- Lymphoedema of the dorsum of the foot

Product features

- Toe cap with Clima Fresh: reliably prevents odour and colonisation by bacteria
- Unique top and bottom principle:
 - Seams moved to the upper and lower surfaces of the toes in the direction of lymphatic drainage
 - Lateral seams give every toe stability for an effective action
 - Each single toe made to measure anatomically for an optimum fit

Seamless toe cap

- More reliable measurements (no longer necessary to calculate the overlap)
- Care to suit the indication for optimum lymphatic drainage (no circular seams)
- Very comfortable to wear, without circular seams
- Outstanding non-slip grip
- Available in variants AD and AG

Individual toe cap

- Increased wall stability due to double compression garments for pronounced forms of oedema over the dorsum of the foot
- Increased treatment compliance due to quick and easy donning
- Individual care options, e.g. nightwear or combination with other product variants

Seamed toe cap

- Individual care possible if different compression classes are needed for the leg and toes
- Outstanding non-slip grip



Seamless toe cap



Individual toe cap



Seamed toe cap

Versions available

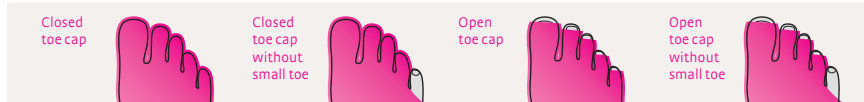

Compression

CCL 1, 2

Product benefits



Clima Comfort



Clima Fresh



Perfect Fit



Variety



Anatomic Fit



Colours

M = Made-to-measure

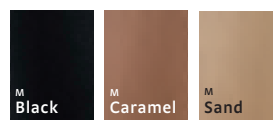

Standard colours

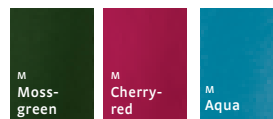
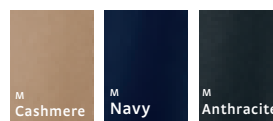

Trend colours

Delivery period up to 10 working days.



mediven sensoo[®]

Supple and soft – for oedema up to stage 1.

Indications

- Primary and secondary lymphoedema, stage 1
- Lipoedema stage 1
- Postoperative and post-traumatic oedema, mild stages
- Caring for keloid

Condition of the connective tissues

Recommended for normal connective tissue.

Product features

- Soft, sheer knit
- Material comfortable to put on
- Soft surface
- Selected extras

Compression

CCL 2

Product benefits



Clima Comfort



Clima Fresh



Perfect Fit



Variety



Anatomic Fit



Colours

M = Made-to-measure

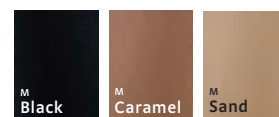



Below knee stocking with open toe

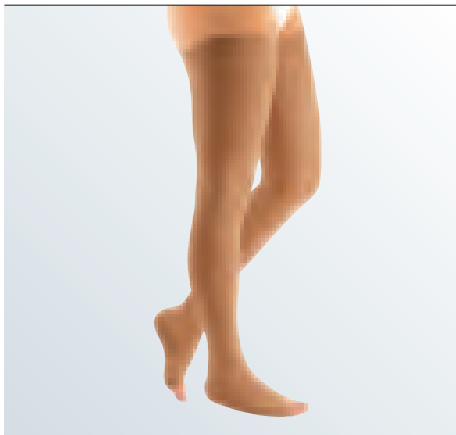

Thigh-length stocking with open toe

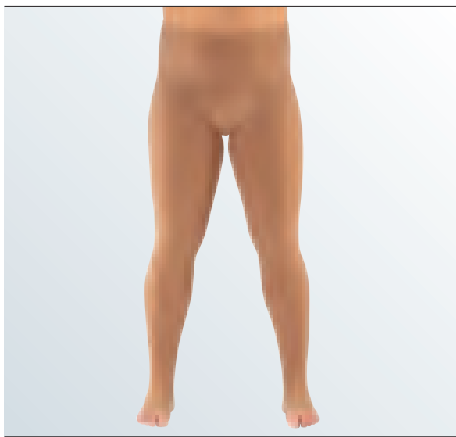

Men's leotard

mediven sensoo® made-to-measure

Versions available

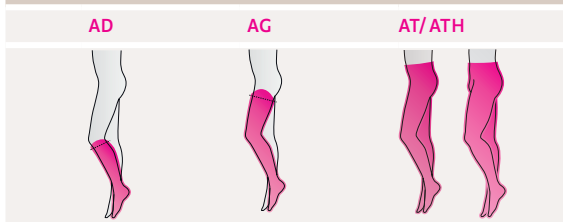

Standard models

Border	AD, AG flat oblique
Style	AT, ATH flat oblique
Gusset	ATH with men's gusset
Foot part	Oblique, open foot

Material composition

	Elastane (EL)	Polyamide (PA)
CCL 2	25 %	75 %



mediven® forte

The strongest round knit model.

Your benefits

- Safe and reliable care, even for severe indications
- Reliable therapy for your customers

Benefits for your customers

- Maximum pressure stability and stiffness (high working pressure for a deep functional effect)
- Extremely hard-wearing seamless material for optimum wearing comfort

Additional benefits

- Extremely soft, extra wide comfort cuffs for the best possible feel
- Clima Fresh over the whole leg for a feeling of freshness around the clock
- Extremely skin-friendly – tested quality to Oeko-Tex Standard 100

Compression

CCL 2, 3

Product benefits

The strong stocking for severe indications.



Clima Fresh



Variety



Perfect Fit



Colours

The article is available in the following colours.

S = Standard

M = Made-to-measure

Trend colours are available.

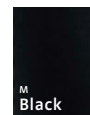

mediven® forte

The strongest round knit model.

Indications

- Varicosis in pregnancy with tendency for severe oedema
- Inflammatory venous disease (superficial thrombophlebitis, varicophlebitis) with tendency for moderate to severe oedema
- Primary and secondary varicosis with tendency for moderate to severe oedema
- Chronic venous insufficiency stage I – III with tendency for moderate to severe oedema / CEAP-classification C2 to C5
- Deep venous thrombosis, post-thrombotic syndrome where there is a tendency for slight to severe oedema

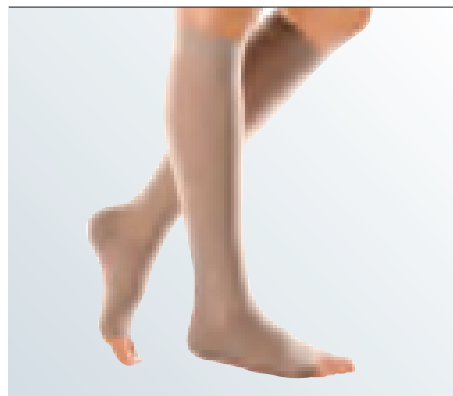

Calf stocking (AD) with open toe

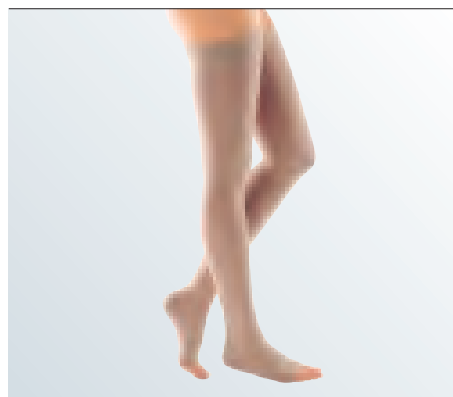

Thigh length stocking (AG) with open toe



Open toe – detail

Length

ℓG regular	72 – 83
ℓG petite	62 – 71
ℓD regular	38 – 43
ℓD petite	33 – 37





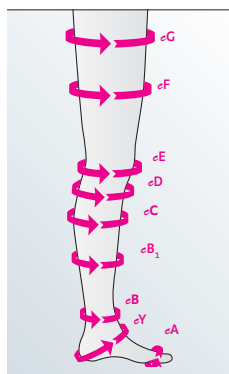









Toe

Standard with open toe
Short foot sizes 36 – 38
Normal foot sizes 39 – 43



Circumferences

Sizes	I	II	III	IV	V	VI	VII
eG thigh with silicone topband	44 – 47	46 – 50	50 – 54	53 – 58	56 – 61	60 – 65	64 – 70
eG thigh with silicone topband extra wide	48 – 53	51 – 57	55 – 61	59 – 65	62 – 70	66 – 74	71 – 80
eG	44 – 53	46 – 57	50 – 61	53 – 65	56 – 70	60 – 74	64 – 80
eF	40 – 47	42 – 51	45 – 55	48 – 58	51 – 62	54 – 67	58 – 72
eE	30 – 37	33 – 40	36 – 42	38 – 44	40 – 46	42 – 48	44 – 50
eD	28 – 33	30 – 35	32 – 37	34 – 39	36 – 41	38 – 43	40 – 45
eC	29 – 34	31 – 36	33 – 38	35 – 40	37 – 42	39 – 44	41 – 46
eB ₁	24 – 26	26 – 28	28 – 31	30 – 33	32 – 35	34 – 37	36 – 39
eB	18 – 20	20 – 22	22 – 24	24 – 26	26 – 28	28 – 30	30 – 32
eY	28 – 30	29 – 32	31 – 34	33 – 36	34 – 38	36 – 40	37 – 41
eA	18 – 21	20 – 23	22 – 25	24 – 27	26 – 29	28 – 31	30 – 33

mediven forte									
Styles	AD	AD pte.	AG / NoB	AG pte. / NoB	AG	AG pte.			
									
	calf	calf petite	thigh	thigh petite	thigh with waist attachment	thigh petite with waist attachment			
					right	left	right	left	
Class 2	Article No. F240x01-7	F247x01-7	F260x01-7	F250x01-7	F263x01-7	F262x01-7	F253x01-7	F252x01-7	
Class 3	Article No. F340x01-7	F347x01-7	F360x01-7	F350x01-7	F363x01-7	F362x01-7	F353x01-7	F352x01-7	
Styles	AT	ATE	AT pte.	AT / U	BT	CT	ET	AT / H	AT / H pte.
									
	panty	one legged panty	panty petite	maternity panty	leggings	capri shorts	cycling short	men's leotard	men's leotard petite
Class 2	Article No. F210x01-7	made-to-measure	F217x01-7	made-to-measure	made-to-measure	made-to-measure	made-to-measure	made-to-measure	made-to-measure
Class 3	Article No. F310x01-7		F317x01-7	made-to-measure	made-to-measure	made-to-measure	made-to-measure	made-to-measure	made-to-measure

See the last page for the article numbers

Standard styles	
Standard	Sizes I – VII, Length normal and petite, Topband normal and wide
Made-to-measure	Available
Special version	Available
Border	AD, tricot border AF and AG tricot border Silicone topband
Gusset	AT, sizes I – III groin gusset Sizes IV – VII narrow gusset at the back up to the waist, AT / U with closed panty top AT / H opening horizontal
Foot part	Open toe Choice of 2 foot lengths Short foot sizes 36 – 38, normal foot sizes 39 – 43

Material composition		
	Elastane (EL)	Polyamide (PA)
CCL 2	21 %	79 %
CCL 3	26 %	74 %



mediven plus®

All you experience is reliability. Compression has never proven so trustworthy.

Your benefits

- Safe and reliable care for a large target group and a large number of indications
- Suitable for HIM and HER due to the opaque look and numerous variants
- Satisfaction of individual customer needs with a wide range of variants, ideal for sensitive and large thighs

Benefits for your customers

- Reliable fit due to the plus-heel with Y-shape, perfectly fitting toe section and broader cuff
- As versatile as your patients' needs
- Excellent durability due to the hard-wearing material

Additional benefits

- Maxi panty top as standard
- Dermatologically tested* and proven to be comfortable even for those who are prone to allergic reactions or have sensitive skin
- Antibacterial effect on the whole leg with Clima Fresh
- Four topbands for individual needs
- Extremely skin-friendly – tested quality to Oeko-Tex Standard 100

* cf. Ben Ammar, F. (DermScan): Clinical evaluation of the skin compatibility of a medical device - application testing realized under dermatological control, Tunis 2012 / 2013.

Compression

CCL 1, 2, 3

Product benefits

The reliable stocking for every day.



cf. Ben Ammar, F. (DermScan): Clinical evaluation of the skin compatibility of a medical device - application testing realized under dermatological control, Tunis 2012/2013.



Clima Comfort



Clima Fresh



Perfect Fit



Variety



Colours

The article is available in the following colours.

S = Standard

M = Made-to-measure

Trend colours are available.

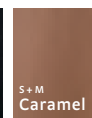
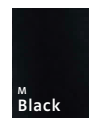
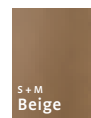

mediven plus®

All you experience is reliability. Compression has never proven so trustworthy.

Indications*

- After sclerotherapy / surgery
- Varicosis in pregnancy with tendency for slight to severe oedema
- Inflammatory venous disease (superficial thrombophlebitis, varicophlebitis) with tendency for slight to moderate oedema
- Thrombosis prophylaxis for mobile patients
- Primary and secondary varicosis with a slight to severe tendency for oedema
- Chronic venous insufficiency stage 1 – 3 with tendency for slight to severe oedema / CEAP-classification C1 to C5
- Deep venous thrombosis, post-thrombotic syndrome with tendency for slight oedema

* The choice of the optimum compression sock depends on the indication and the patient's individual needs.



Below-knee stocking

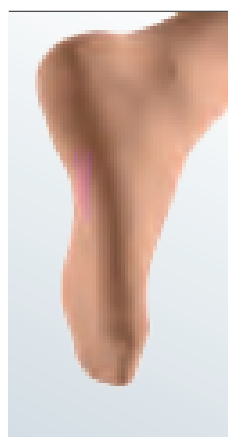

Plus-heel and sole reinforcement

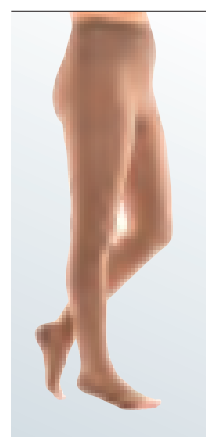



















Maxi panty top as standard

Circumferences

Sizes	I	II	III	IV	V	VI	VII
eG thigh with silicone topband	43 – 48	45 – 52	49 – 56	53 – 60	56 – 64	60 – 68	64 – 72
eG thigh with silicone topband extra wide	49 – 57	53 – 62	57 – 67	61 – 72	65 – 77	69 – 81	73 – 85
eG	43 – 57	45 – 62	49 – 67	53 – 72	56 – 77	60 – 81	64 – 85
eF	39 – 52	41 – 56	44 – 60	47 – 65	50 – 69	53 – 73	57 – 78
eE	30 – 37	33 – 40	35 – 43	37 – 45	39 – 48	41 – 51	42 – 53
eD	27 – 33	29 – 36	32 – 39	34 – 42	36 – 45	38 – 48	40 – 50
eC	28 – 34	30 – 37	33 – 40	35 – 43	37 – 46	39 – 49	41 – 51
eB ₁	23 – 27	24 – 29	26 – 32	29 – 35	31 – 37	33 – 39	35 – 41
eB	18 – 20	20 – 22	22 – 24	24 – 26	26 – 28	28 – 30	30 – 32
eY	26 – 31	28 – 33	29 – 35	31 – 37	32 – 38	33 – 40	34 – 42
eA	17 – 22	19 – 24	21 – 26	23 – 29	25 – 32	27 – 34	28 – 35

Length

eG regular	72 – 83
eG petite	62 – 71
eD regular	39 – 44
eD petite	34 – 38

mediven plus							
Styles	AD	AD pte.	AG / TBb	AG / TBb pte.	AT	AT + maxi panty top	AT pte.
							
	calf	calf petite	thigh with topband	thigh petite with topband	panty	panty with maxi panty top	panty petite
Class 1	Article No. 4A40x01-7	4A47x01-7	4A61x01-7	4A51x01-7	4A10x01-7	4AZ0x01-7	4A17x01-7
Class 2	Article No. 4B40x01-7	4B47x01-7	4B61x01-7	4B51x01-7	4B10x01-7	4BZ0x01-7	4B17x01-7
Class 3	Article No. 4C40x01-7	4C47x01-7	4C61x01-7	4C51x01-7	4C10x01-7	4CZ0x01-7	4C17x01-7
Styles	ATE	ATE pte.	AT / U	AT / U pte.	CT	BT	
							
	one legged panty	one legged panty petite	maternity panty	maternity panty petite	capri shorts	leggings	
	right	left	right	left			
Class 1	Article No. 4AE3x01-7	4AE2x01-7	4AV3x01-7	4AV2x01-7	4A20x01-7	4A27x01-7	
Class 2	Article No. 4BE3x01-7	4BE2x01-7	4BV3x01-7	4BV2x01-7	4B20x01-7	4B27x01-7	made-to-measure
Class 3	Article No. 4CE3x01-7	4CE2x01-7	4CV3x01-7	4CV2x01-7	4C20x01-7	4C27x01-7	made-to-measure
Styles	ET	AT / H	AT / H pte.	AG	AG pte.		
							
	cycling short	men's leotard	men's leotard petite	thigh with waist attachment	thigh with waist attachment petite		
				right	left	right	left
Class 1	Article No.	4A30x01-7	4A37x01-7	4A63x01-7	4A62x01-7	4A53x01-7	4A52x01-7
Class 2	Article No. made-to-measure	4B30x01-7	4B37x01-7	4B63x01-7	4B62x01-7	4B53x01-7	4B52x01-7
Class 3	Article No.	4C30x01-7	4C37x01-7	4C63x01-7	4C62x01-7	4C53x01-7	4C52x01-7

See the last page for the article numbers

Standard styles	
Standard	Sizes I – VII, Length normal and petite Topband normal and wide
Made-to-measure	Available
Special versions	Available
Border	AD, tricot border AF and AC topband basic Waist attachment
Gusset	AT, sizes I – III groin gusset Sizes IV – VII narrow, gusset at the back up to the waist, maxi panty top AT / U with closed panty top AT / H opening horizontal
Foot part	With open or closed toe Universal foot size, shoe sizes 36 – 43

Material composition		
	Elastane (EL)	Polyamide (PA)
CCL 1	25 %	75 %
CCL 2	31 %	69 %
CCL 3	37 %	63 %



Flat knit – arm garments

The mediven high-quality flat knit range offers you clear advantages.

Following the motto “Live, Laugh, Love” medi has developed an arm sleeve collection, that offers lymph patients a unique selection. The arm sleeves are available in different colours and can be refined with attractive patterns on demand. The advantage: The arm sleeves integrate themselves into the wardrobe of the patient – this also benefits the compliance of the patient. This variety only exists with medi.

Arm garment	Oedema stage	Knitting technique	S = Standard M = Made-to-measure	Page
mediven 550 arm	1, 2, 3	flat knit	M	46
mediven esprit	1, 2	flat knit	S, M	50
mediven harmony	1	round knit	S	54



mediven[®] 550 arm

Highest wall stability and unlimited variety for oedema up to stage 3.

Indications

- Primary and secondary lymphoedema stages 1, 2 and 3
- Lipoedema stages 1, 2 and 3
- Elephantiasis
- Keloid treatment, e.g. after burns
- Postoperative and post-traumatic oedema

Condition of the connective tissue

Recommended for soft to firm connective tissue.

Product features

- Highest working pressure
- Over 2,100 combination options with special extras
- Numerous variants, such as arm cuffs for double and multipart garments
- Fashionable variety: 3 standard colours, 7 trend colours and 3 unique design elements

Best of all:
the trend colours and
design elements are
available at no extra charge.

Design elements

LIVE
LAUGH
LOVE

Live Laugh Love

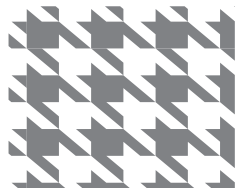

Timeless

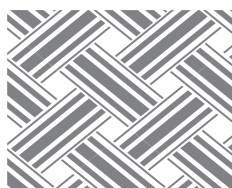

Sportive

The design elements can be freely combined with the standard and trend colours.

Compression

CCL 1, 2, 3

Product benefits



Perfect Fit



Clima Comfort



Variety



Clima Fresh



Anatomic Fit



Colours

M = Made-to-measure

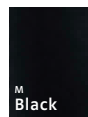

Standard colours

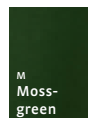
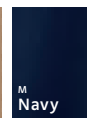
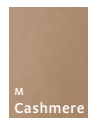

Trend colours

Delivery period up to 10 working days.

**mediven® 550 arm
made-to-measure**

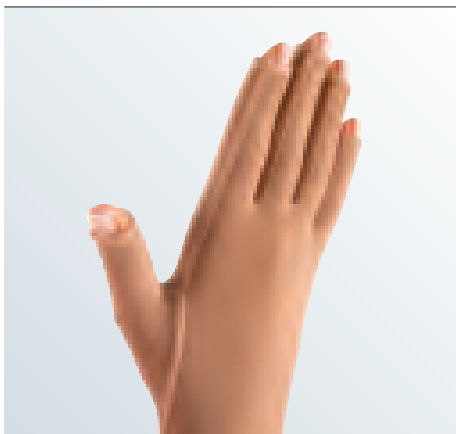

Hand piece (seam outside)



With shoulder strap

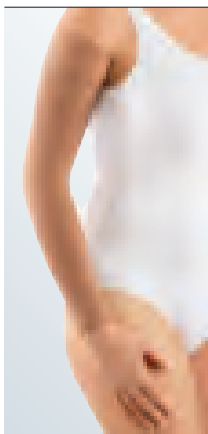

Armsleeve CG

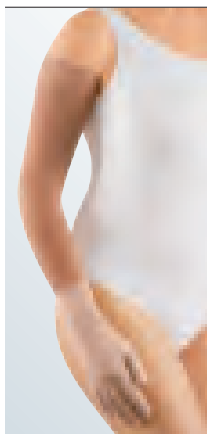

**With non-slip
topband at G and
hand piece with
long fingers and
thumb base**

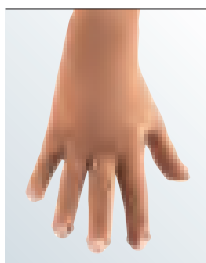

**Hand piece with
lymph pad**

Variants

AD Long glove to D	AE Long glove to E	AF Armsleeve with hand to F	AG Armsleeve with hand to G
CD Armsleeve without hand to D	CE Armsleeve without hand to E	CF Armsleeve without hand to F	CG Armsleeve without hand to G
DF Arm cuff	DG Arm cuff	EG Arm cuff	FG Arm cuff

Attachment options

One-piece (AG / AF) Arm with hand knitted on	Topband At C or F	Shoulder strap	Bra attachment
Two-piece (CG + AC1) Arm with separate hand piece			

Hand section AC1

Finger piece		Hand piece without fingers, with thumb opening		Hand piece without fingers, with base of thumb		Hand piece with short fingers, with base of thumb	
Hand piece with long fingers, with base of thumb		Hand piece with closed fingers					

Standard models

Border proximal	Flat oblique with all variants apart from AC1. For AC1 porous, straight border.
Border distal	Porous straight border: CD, CE, CF, CG
Finger	Without fingers with base of thumb, open / closed fingers with base of thumb: AE, AF, AG, AC1, AD
Fingerpiece	Open or closed

Material composition

	Elastane (EL)	Polyamide (PA)
CCL 1	12%	88%
CCL 2	16%	84%
CCL 3	26%	74%



mediven esprit®

Comfortable and effective – for arm oedema up to stage 2.

Indications

- Primary and secondary lymphoedema stages 1 and 2
- Lipoedema stages 1 and 2
- Keloid treatment, e.g. after burns
- Postoperative and post-traumatic oedema

Condition of the connective tissue

Recommended for normal to firm connective tissue.

Product features

- Supple knit
- Many combination options with special extras
- Numerous variants for double and multipart garments
- Fashionable variety: 3 standard colours, 7 trend colours and 3 unique design elements

Best of all:
the trend colours and design
elements are available at no
extra charge.

Design elements

LIVE
LAUGH
LOVE

Live Laugh Love

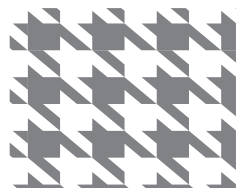

Timeless

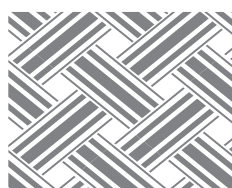

Sportive

The design elements can be freely combined with the standard and trend colours.

Compression

CCL 1, 2, 3

Product benefits



Perfect Fit



Clima Comfort



Variety



Clima Fresh



Anatomic Fit

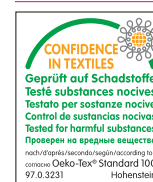

Colours

S = Standard

M = Made-to-measure

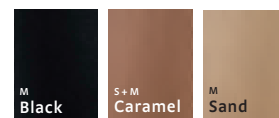

Standard colours

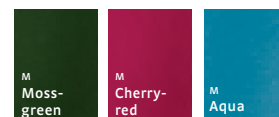
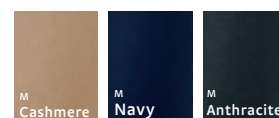

Trend colours

Delivery period up to 10 working days.

mediven esprit® made-to-measure

Variants

AD Long glove to D	AE Long glove to E	AF Armsleeve with hand to F	AG Armsleeve with hand to G
CD Armsleeve without hand to D	CE Armsleeve without hand to E	CF Armsleeve without hand to F	CG Armsleeve without hand to G

Attachment options **Topband** **Shoulder strap** **Bra attachment**

One-piece (AG / AF)
Arm with hand knitted on

Two-piece (CG + AC1)
Arm with separate hand piece

Hand section AC1

Hand piece without fingers, with thumb opening	Hand piece without fingers, with base of thumb	Hand piece with short fingers, with base of thumb
Hand piece with long fingers, with base of thumb	Hand piece with closed fingers	



Armsleeve with hand to G

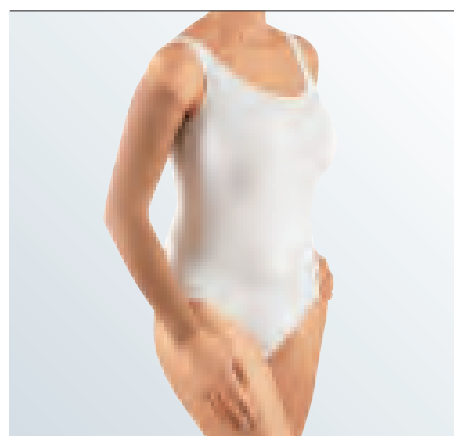

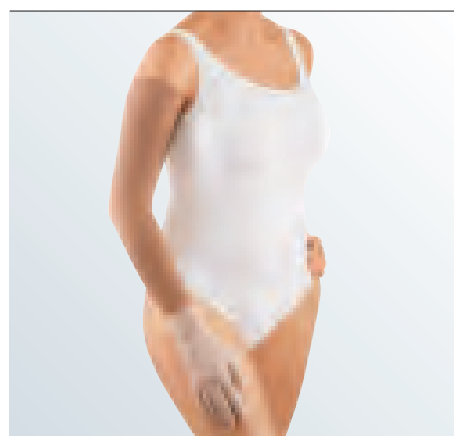

With non-slip topband at G



With non-slip topband at G and hand part with long fingers and thumb base

Standard models	
Border proximal	Flat oblique with all variants apart from AC1. For AC1 porous, straight border.
Border distal	Porous, straight border: CD, CE, CF, CG
Finger	Without fingers with base of thumb, open / closed fingers with base of thumb: AE, AF, AG, AC1, AD

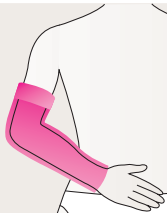
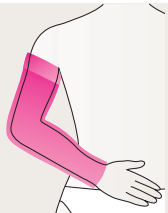
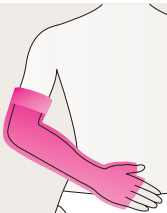
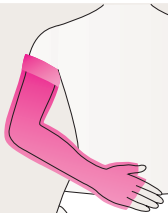
Material composition		
	Elastane (EL)	Polyamide (PA)
CCL 1	12 %	88 %
CCL 2	16 %	84 %
CCL 3	26 %	74 %

Variants					
Styles	CG / SN	CG / SN long	AG / SN	AG / SN long	AC ₁
					
	armsleeve with topband	armsleeve long with topband	combined with topband	combined with topband long	glove / mittens with compr. fingers
CCL1	J1H1701-5	J1G1701-5	J151701-5	J161701-5	J110711-5
CCL2	J2H1701-5	J2G1701-5	J251701-5	J261701-5	J210711-5

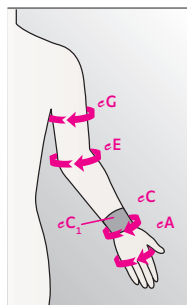

Standard sizes						
Sizes	I	II	III	IV	V	
eA	17.0 – 19.0	18.0 – 20.0	19.0 – 22.0	21.0 – 24.0	23.0 – 27.0	
eC	15.0 – 17.0	17.0 – 19.0	19.0 – 21.0	21.0 – 23.0	23.0 – 25.0	
eE	25.0 – 27.5	27.0 – 29.5	29.0 – 32.0	31.0 – 34.0	33.0 – 37.0	
eG	28.0 – 32.0	30.0 – 34.0	32.0 – 37.0	35.0 – 40.0	38.0 – 44.0	
Length CG: standard 40 – 44 cm, long 44 – 48 cm						
Colour: caramel						

Circumference / Hand part (cm)					
Sizes	I	II	III	IV	V
a	17.0 – 19.0	18.0 – 20.0	19.0 – 22.0	21.0 – 24.0	23.0 – 27.0
b	18.0 – 20.0	19.0 – 21.0	20.0 – 23.0	22.0 – 25.0	24.0 – 28.0
c	15.0 – 17.0	17.0 – 19.0	19.0 – 21.0	21.0 – 23.0	23.0 – 25.0
c ₁	16.0 – 19.0	18.0 – 21.0	20.0 – 23.0	22.0 – 25.0	24.0 – 27.0

Circumference / Fingers (cm)						
Variant AC ₁		I	II	III	IV	V
Thumb	top	5.5	6.5	7.5	8.5	9.5
	bottom	6.5	7.5	8.5	9.5	10.5
Index finger	top	4.5	5.5	6.5	7.5	8.5
	bottom	5.5	6.5	7.5	8.5	9.5
Middle finger	top	4.5	5.5	6.5	7.5	8.5
	bottom	5.5	6.5	7.5	8.5	9.5
Ring finger	top	4.0	5.0	6.0	7.0	8.0
	bottom	5.0	6.0	7.0	8.0	9.0
Little finger	top	3.5	4.5	5.5	6.5	7.5
	bottom	4.5	5.5	6.5	7.5	8.5

Length / Hand part (cm), all sizes	
AB	3.5 – 4.5
AC	10.0 – 12.0
AC ₁	15.0 – 16.0

Length / Fingers (cm)	
Thumb	3.5 – 4.5
Index finger	4.5 – 5.5
Middle finger	5.5 – 6.5
Ring finger	4.5 – 5.5
Little finger	3.5 – 4.5



mediven harmony®

Comfortable and effective round-knitted
armsleeve.

Benefits

- The double ellipses on the point and in the crease of the elbow offer freedom of movement. They are designed to assist with lymphatic drainage and to reduce wrinkles to a minimum to prevent soreness.
- High containment: high wall stability with a gentle touch of supple knit
- Unmatched well-being: the innovative fabric structure stimulates the tissue and exerts a pleasant massage effect
- The anatomical shape of the armsleeve ensures easy and correct donning and doffing
- The hand part of the combined armsleeve offers two flat seams and a wedge at the web of the thumb. This reduces the tension and increases compliance.
- The silicone topband is knitted to the armsleeve with a flat and unconscious seam which secures hold but not sticking because of air permeability.

Additional benefits

- Perfect Fit
- The skin feels comfortable all year round with Clima Comfort
- Variety: available in 2 compression classes, 3 colours and 2 hand pieces
- Premium quality RAL standard
- Latex free
- Machine wash gentle cycle at 40° C and cool tumble dry

Compression

CCL 1, 2

Product benefits



Perfect Fit

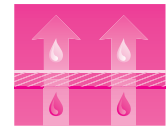

Clima Comfort



Variety



Double ellipses



Colours

S = Standard

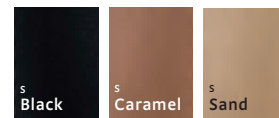

* Black: minimum order quantities of 20 pieces per size and variant; approx. 4 weeks delivery period

mediven harmony[®]

Comfortable and effective round-knitted armsleeve.

Indications*

- Shoulder arm vein thrombosis
- Post-operative and post-traumatic oedema
- Primary and secondary stage 1 lymphedema of the arm
- Hand part (glove): prevention of accumulation of lymph fluid in the hand area while wearing a medical compression armsleeve

* These indications should be seen as a recommendation. The garment model and the strength of pressure required, i.e. the compression class, depend on the diagnosis, the treatment site, the clinical findings and the patient's susceptibility to oedema. Please also consider the patient's individual requirements and the circumstances (comorbidities, mobility, BMI, state of their skin and tissues, etc.).



Narrow napped silicone topband



Combined armsleeve with hand part AG, sand



Ellipse in the elbow crease



Ellipse on the point of the elbow

Variants (all variants available as regular or extra wide top)

AG combined armsleeve

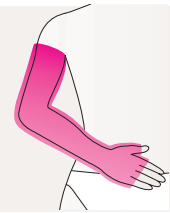

Regular CCL 1: 2Y10x01-8
CCL 2: 2Z10x01-8
Extra wide CCL 1: 2Y10x11-8
CCL 2: 2Z10x11-8

AG combined armsleeve with topband

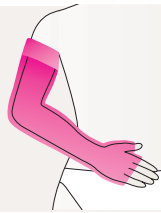

Regular CCL 1: 2Y11x01-8
CCL 2: 2Z11x01-8
Extra wide CCL 1: 2Y11x11-8
CCL 2: 2Z11x11-8

AG combined armsleeve with shouldercap



Regular CCL 1: 2Y15x01-8
CCL 2: 2Z15x01-8
Extra wide CCL 1: 2Y15x11-8
CCL 2: 2Z15x11-8

CG

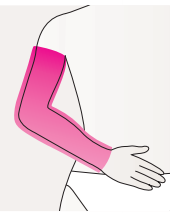

Regular CCL 1: 2Y00x01-8
CCL 2: 2Z00x01-8
Extra wide CCL 1: 2Y00x11-8
CCL 2: 2Z00x11-8

CG with topband

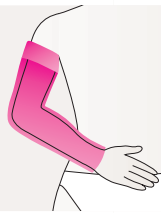

Regular CCL 1: 2Y01x01-8
CCL 2: 2Z01x01-8
Extra wide CCL 1: 2Y01x11-8
CCL 2: 2Z01x11-8

CG with shouldercap



Regular CCL 1: 2Y05x01-8
CCL 2: 2Z05x01-8
Extra wide CCL 1: 2Y05x11-8
CCL 2: 2Z05x11-8

x = colour; replace with 5 for black, 7 for caramel or 8 for sand

Armsleeve	Size I		Size II		Size III		Size IV	
Circumference (cm)	Regular	Extra wide	Regular	Extra wide	Regular	Extra wide	Regular	Extra wide
eG	25,5 – 28,0	28,5 – 31,0	28,0 – 30,5	30,5 – 33,5	30,0 – 33,0	33,0 – 36,0	32,0 – 35,0	35,0 – 38,5
eF	23,5 – 25,5	25,5 – 28,0	25,0 – 27,5	27,5 – 30,0	27,5 – 30,0	30,0 – 33,0	29,5 – 32,0	32,0 – 35,0
eE	23,0 – 25,0	24,0 – 26,0	24,5 – 26,5	26,5 – 29,0	26,0 – 28,5	28,5 – 31,0	27,5 – 30,0	30,0 – 33,0
eD	22,0 – 24,0	24,0 – 26,0	23,0 – 25,0	25,0 – 27,5	24,0 – 26,0	26,0 – 28,5	25,0 – 27,5	28,0 – 30,5
eC1 = 100%*	15,0 – 16,5		16,5 – 18,0		18,0 – 19,5		19,5 – 21,0	
eC	13,5 – 14,5		14,5 – 15,5		16,0 – 17,5		17,5 – 19,0	
eA	15,0 – 18,0		16,0 – 19,0		17,0 – 20,0		19,0 – 22,0	

Armsleeve	Size V		Size VI		Size VII		Size VIII**	
Circumference (cm)	Regular	Extra wide	Regular	Extra wide	Regular	Extra wide	Regular	Extra wide
eG	33,5 – 36,5	37,0 – 40,5	36,0 – 39,5	39,5 – 43,0	38,0 – 41,5	41,5 – 45,5	40,5 – 44,5	45,0 – 49,5
eF	31,0 – 34,0	34,0 – 37,0	33,0 – 36,0	36,0 – 39,5	35,0 – 38,5	38,5 – 42,0	37,5 – 41,0	41,5 – 45,5
eE	29,0 – 31,5	31,5 – 34,5	30,5 – 33,5	33,5 – 36,5	32,5 – 35,5	35,5 – 39,0	35,0 – 38,5	38,5 – 42,0
eD	27,0 – 29,5	29,5 – 32,0	28,5 – 31,0	31,0 – 34,0	30,5 – 33,5	33,5 – 36,5	33,0 – 36,0	36,0 – 39,5
eC1 = 100%*	21,0 – 23,0		23,0 – 25,0		25,0 – 27,5		27,5 – 30,0	
eC	19,0 – 20,5		20,5 – 22,5		22,5 – 24,5		25,0 – 27,5	
eA	20,0 – 23,0		22,0 – 25,0		24,0 – 27,0		26,0 – 29,0	

* Measurement eC1 is 5 cm above eC

** Size VIII: Minimum order quantity of 20 pieces per colour and variant; delivery period approx. 4 weeks

Length (cm)

Standard length 41 – 47

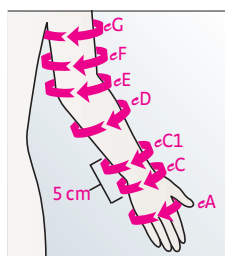

Measurement mediven harmony

Variants

**AC₁ hand piece
without fingers with thumb base**

**AC₁ glove
with compressive fingers**



CCL 1: Art.No. 2Y20x02-7
CCL 2: Art.No. 2Z20x02-7

CCL 1: Art.No. 2Y21x02-7
CCL 2: Art.No. 2Z21x02-7

Circumference / Hand part (cm)

Sizes	II	III	IV	V	VI	VII
eC1*	15,0 – 18,0	17,0 – 20,0	19,0 – 21,5	21,0 – 23,5	23,0 – 26,0	25,5 – 30,0
eC	13,5 – 15,5	15,0 – 18,0	17,0 – 20,0	19,0 – 21,0	20,0 – 23,5	22,5 – 27,5
eB	15,5 – 20,0	17,5 – 21,0	19,5 – 23,0	20,5 – 24,0	22,5 – 26,0	24,5 – 30,0
eA	15,0 – 19,0	17,0 – 20,0	19,0 – 22,0	20,0 – 23,0	22,0 – 25,0	24,0 – 29,0

Circumference / Fingers (cm) / Sizes

Sizes		II	III	IV	V	VI	VII
Thumb	Bottom eX	7,0	7,5	8,0	8,5	9,0	10,0
	Top eZ	6,0	6,5	6,5	7,0	7,5	8,0
Index finger	Bottom eX	6,5	7,0	7,5	8,0	8,5	9,5
	Top eZ	5,0	5,5	6,0	6,0	6,5	7,0
Middle finger	Bottom eX	6,5	7,0	7,5	8,0	8,5	9,5
	Top eZ	5,0	5,5	6,0	6,0	6,5	7,0
Ring finger	Bottom eX	6,0	6,5	7,0	7,0	7,5	9,0
	Top eZ	5,0	5,0	5,5	5,5	6,0	6,5
Little finger	Bottom eX	5,5	6,0	6,0	6,5	7,0	8,0
	Top eZ	4,5	4,5	5,0	5,0	5,5	6,0

* Measurement eC1 is 5 cm above eC

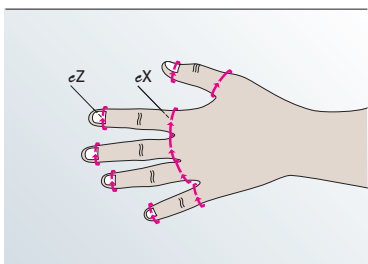
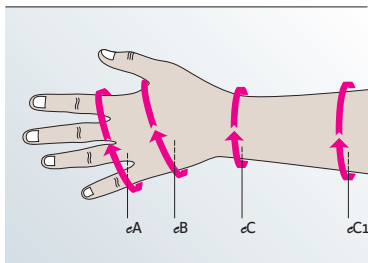

Circumference eZ is measured
at the nailbed
Circumference eX is measured
at the base of the finger

Length / Hand part (cm), all sizes

AB	3,5 – 4,5
AC	10,0 – 12,0
AC ₁	15,0 – 16,0

Length / Fingers (cm)

Thumb	3,5 – 4,5
Index finger	4,5 – 5,5
Middle finger	5,5 – 6,5
Ring finger	4,5 – 5,5
Little finger	3,5 – 4,5

Material composition armsleeve

	Elastane (EL)	Polyamide (PA)
CCL 1	34 %	66 %
CCL 2	43 %	57 %

Material composition hand part

	Elastane (EL)	Polyamide (PA)
CCL 1	18 %	82 %
CCL 2	22 %	78 %





The Whitaker pouch from medi

For treatment of scrotal oedema in palliative or acute situations.

- Available in 3 sizes of pouch
- 100 cm belt as standard
- 2 sizes of extension available for belt

Fitting: The pouch is designed to fit the scrotum only, but may include the penis for palliative patients.

Checking and refitting:

- You are advised to teach your patient or their carers to check the skin condition regularly
- Due to the possibility of rapid reduction of the oedema with this garment you may need to re-measure for a smaller garment more frequently than standard garments
- Regular reviews are recommended



Whitaker pouch

Whitaker Pouch

Girth of scrotum	Size	Code
33 – 40 cm	Small	700-2
41 – 48 cm	Medium	700-3
49 – 56 cm	Large	700-4

Waist circumference	Standard belt 1025402	40 cm extension required 1025404	80 cm extension required 1025401
100 – 150 cm	●		
145 – 190 cm	●	●	
185 – 225 cm	●		●

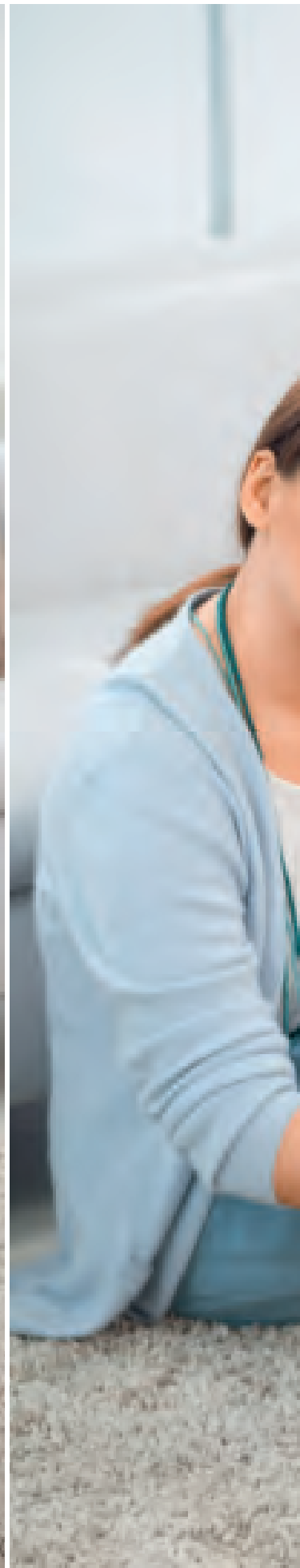



Commercial products

Sometimes it is difficult for patients to put on their compression stockings. medi offers a large selection of practical donning and doffing aids. For patients with sensitive skin there is also a special skin care series by medi. The rich ingredients pamper the skin and help it regenerate.

medi

Donning and doffing aids

medi Butler

Your benefits:

- Different Butlers: the right solution for every customer requirement
- Increase add-on sales
- Time saving with uncomplicated donning and doffing

Benefits for your customers:

- Quick and simple donning of compression stockings
- Less effort required
- Wide choice for the most individual demands

medi Export Butler with long handles

The ideal donning aid for all compression stockings wearers who can comfortably don their stockings without assistance. The long handle ensures maximum stability when putting on compression stockings and pantyhose.

Article No. 6900041

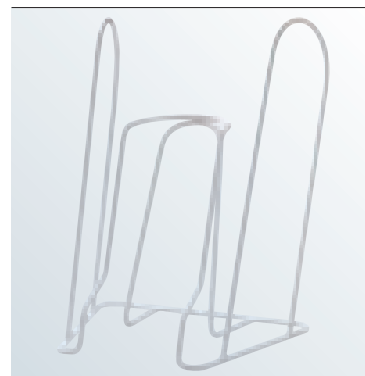

medi Butler with short handles

Perfectly suited for donning armsleeves or for helping a carer put compression stockings on to the person being cared for.

Article No. 6900032



medi Hospitalbutler

Adjustable diameter with hard paint finish coating.

Article No. 6900062



medi Reha-Butler

The medi Reha-Butler is equipped with a new folding mechanism to allow stocking application without pointing the toes.

Article No. 6900056

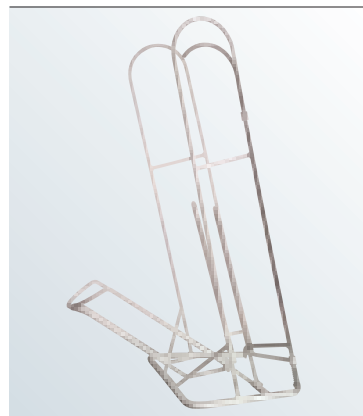

medi Butler with variable handles

The donning aid for stocking wearers with considerably restricted freedom of movement.

The handle length can be adjusted between 37 and 58 cm.

Article No. 6900051

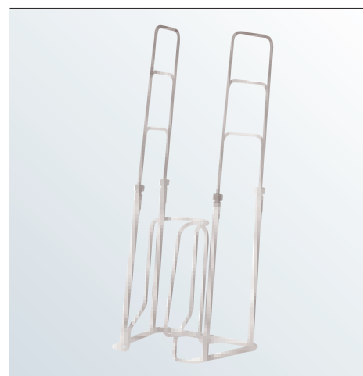

medi Butler for pantyhose

The medi pantyhose Butler eases donning of compression pantyhose.

Article No. 6900055



medi Big (XXL) Butler

The stirrup of the medi Big Butler has a larger diameter. This makes allowance for larger circumferences which are often associated with less freedom of movement.

Article No. 6900102



medi Travel Butler

With its low weight and simple handling the medi travel Butler is your ideal travelling companion. Can be dismantled into individual parts, includes screwdriver and bag.

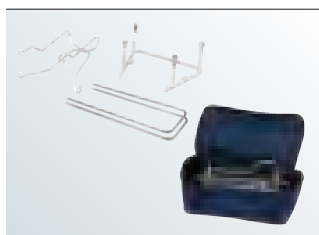

Article No. 6900054



medi Arm Butler

The medi Arm Butler eases donning of compression armsleeves.

Article No. 6900057

medi Arm-Big Butler

Article No. 6900103



medi 2in1

- Your compression stocking glides up over your heel effortlessly
- For all garment lengths
- For open and closed toes
- Hard-wearing and tear-resistant
- Light and folds up – very compact and portable

Article No.	Description
6900013	medi 2in1

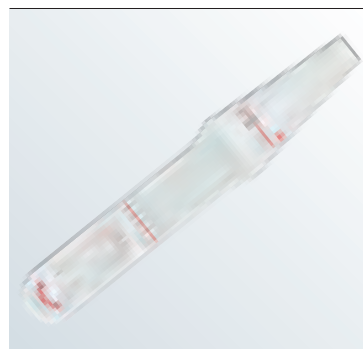

medi 2in1

medi Butler Off

Out of the stocking in seconds

The medi Butler Off helps you take off your compression stocking without tiresome bending and without having to pull hard. To take the stocking off, simply slide the medi Butler Off into the compression stocking and push it off downwards over the heel. This avoids damaging the skin and the knit of the compression stocking (not recommended for mediven forte and flat-knitted stockings).

Article No.	Description
6900362	medi Butler Off



medi Butler off

Dressing aids

Article No.	Description
6900022	Dressing aids (unit with 40 pieces)



Dressing aid

Rubber gloves

- Sizes: small, medium and large
- Box with 12 pairs per size
- Material: 100 % Latex

Article No.	Description
6901012	Rubber gloves Size small
6901013	Rubber gloves Size medium
6901014	Rubber gloves Size large



Rubber gloves



medi skin care

Compression garments are the central component of lymph therapy. Skin care is an important complement to compression garments.

Your benefits

- Increase add-on sales / present as a full-line provider
 - Confidence that the ingredients are perfectly matched to the compression garments
 - Increase customer satisfaction by supplying ideal care for vein-stressed skin
 - Decreases wear and tear on the compression garments by encouraging smooth soft skin
-

An important tip for patients with allergies

All products meet the highest demands and are produced free of parabens (preservatives) and wool fat alcohols, and are latex-free.

The medi care products do not have a use-by or expiry date. They are marked with an "opened tub" and a month. This means that as soon as the tube has been opened and the contents are being used, the product should be used within 6, 9, or 12 months, as with shower gels, shampoos, etc.

medi skin care

The development of a lymph disease increases the burden on the skin. The stretched wall of the vein leaks fluids into the surrounding tissue. The increased loss of water from the surface of the skin makes it more prone to injury. In order to enhance the success of compression therapy, two products have been developed to meet the specific requirements of an affected leg.

medi day – care gel for day time use

Benefits

- Fresh feeling all day long.
- Reduces the feeling of tension and the sensitivity of the skin.
- Contains horse chestnut for firmer vessel walls.
- Refreshing menthol and witch hazel stabilises the tissue structure.

Use medi day directly before putting on the compression garments and let the day begin!

Article No.	Description
P400005	medi day with 50 ml (unit with 6 pieces)
P400006	medi day with 150 ml (unit with 6 pieces)
P400007	medi day with 500 ml (1 piece)

medi night – care cream for night time use

Benefits

- For a comforting recovery overnight.
- Enhances the regeneration of the stressed skin.
- With jojoba oil – for a soothing action on the outer skin layer.

Apply medi night after taking the compression stockings off – for a relaxing night's sleep.

Article No.	Description
P500005	medi night with 50 ml (unit with 6 pieces)
P500006	medi night with 150 ml (unit with 6 pieces)
P300005	Duplo pack medi with 3 pieces medi day (50 ml), 3 pieces mediven night (50 ml)



medi day



medi night

medi fresh – cooling spray

Benefits

- Instant refreshment for when you are out and about.
- Menthol gives your skin a cooling sensation.

Easy to use: spray directly onto the garment at any time and enjoy an immediate soothing effect.

Article No.	Description
P900006	medi fresh with 100 ml (unit with 6 pieces)



medi fresh

medi soft – gentle cream foam

Benefits

- Moisturising skin care around the clock.
- Horse chestnut tones up the vessel wall and urea (10) makes your skin smooth and supple.
- The foam is absorbed quickly and completely.
- Provides additional grip for compression stockings with a topband.

Simply apply in the mornings and evenings and pamper your skin with extra moisture.

Article No.	Description
P800006	medi soft 125 ml (unit with 6 pieces)



medi soft

medi foot care

Carefully selected natural ingredients calm, pamper and care for your feet. Old skin is gently removed. Treat yourself to a high standard of relaxation and care – a short break for body and soul.

medi novee – relaxing footbath lotion

Sink into your relaxing feel-good foot bath.

- Enjoy the soothing and relaxing effect.
- Hops help soothe and relieve inflammation and pamper your feet.

Relax your feet for 10 minutes every day – the short break for body and soul.

Article No.	Description
P940001	medi novee with 150 ml (unit with 6 pieces)

medi smooth – natural foot scrub

Experience a foot massage and scrub away dead skin cells for soft, silky skin.

- The finely ground pumice stone gently removes old skin from the heel and balls of the feet.
- You will notice how your feet will feel smooth and soft to touch.

Apply to moist skin once or twice a week and gently massage it in, rinse with warm water.

Article No.	Description
P940002	medi smooth with 150 ml (unit with 6 pieces)

medi blando – intensive care

The pure care experience for your feet.

- The 15 % urea content makes blando the effective highlight when caring for your feet.
- It provides your feet with moisture and intensive care.
- Panthenol and marigold heal wounds and relieve inflammation.

Massage medi blando into your feet each evening.

Article No.	Description
P940003	medi blando with 150 ml (unit with 6 pieces)



medi novee



medi smooth



medi blando

medi textile care

Gentle care for hand washing your garments.

medi clean

For the easy care of your compression garments - anytime, anywhere.

The special washing liquid is specifically compatible for use with compression garments, cleaning with the utmost of care.

Article No.	Description
-------------	-------------

P920006	medi clean with 150 ml (unit with 6 pieces)
---------	---



medi clean

medi spot ex

The clever solution for stain-free compression garments.

Use before the wash, the spot removal stick medi spot ex removes shoe marks from the garment's toe or heel.

Article No.	Description
-------------	-------------

P930005	medi spot ex with 15 ml (unit with 6 pieces)
---------	--



medi spot ex

medi fix

Adhesive lotion for compression stockings and sleeves with tricot border for a secure fit.

Article No.	Description
-------------	-------------

1023105	medi fix with 50 ml (unit with 6 pieces)
---------	--



medi fix

medi laundry net

Gentle washing

Gentle care helps compression stockings maintain their comfort and their medical efficacy.

The medi laundry net is the ideal aid for caring for compression stockings. The net structure protects the fabric against damage during the daily wash, but does not hinder the removal of dirt particles or soap residues.

Article No.	Description
1020585	medi laundry net (unit with 15 pieces)



medi laundry net





Small, but highly effective – medi Lymphpads

Professional therapy support.

Why use medi Lymphpads?

- They stimulate the microcirculation
- They increase lymph drainage
- They loosen tissue induration and fibrosis
- They support treatment of oedema

Product strengths

- Active breathing material
- Can be trimmed to the desired size and thus have very flexible handling
- Washable up to 40°C

Handling in detail

medi Lymphpads are safe and simple to use. They can be trimmed to size or used as whole sheets. During the decongestion phase the structured surface is placed on the skin and secured with bandages. If required, the lymphpads can alternatively be integrated in the compression garment during the maintenance phase.

When are medi Lymphpads used?

medi Lymphpads are used for specific pressure distribution or to increase pressure over critical zones (e.g. around the malleoli or over the dorsum of the hand). In these areas, the compression may not always be adequate due to the patient's physical situation. Optimum results are then achieved in combination with the medi Lymphpads.



Ribbed lymphpads



Fine napped lymphpads



Coarse napped lymphpads

Model	SU	Art. No.
ribbed	Pack of 2	7 500 002
ribbed	Pack of 10	7 500 001
fine napped	Pack of 2	7 500 012
fine napped	Pack of 10	7 500 011
coarse napped	Pack of 2	7 500 022
coarse napped	Pack of 5	7 500 025
Size lymphpad: 28,5 x 19,5 cm		





CIRCAID

circaid®

Inelastic and instantly adjustable compression garments for the treatment of lymphatic diseases.

circaid products enable patient engagement earlier in the treatment of lymphatic diseases and improve compliance with compression therapy.

circaid products are:

- Cost-effective compared to bandages
- Time saving compared to bandages
- Safer and simpler treatment compared to bandages: no more wrinkles and complicated bandaging techniques
- Better outcomes for your patients: self managing techniques improve patient compliance

Empower your patients now!



Compression therapy by the specialist

medi offers the most comprehensive line
of compression garments for all individual needs.

The inelastic range of circaid is the cost-effective alternative to short stretch and multi-layer bandage systems. circaid juxtafit products guarantee a constant compression level and feature a fast and easy donning and doffing system. The ability to instantly readjust the circaid juxtafit system helps to consistently apply compression to a reducing limb. This is not possible with bandaging without completely removing the layers. circaid garments promote self-management and thus an increased patient compliance as well as an improved quality of life.

Inspiration from nature.

Giraffes have venous pressures of more than 250 mmHg at their ankles, three times more than humans. However, giraffes do not suffer from lymphoedema or venous disorders. The answer is the skin: giraffe skin is inelastic, meaning it does not stretch. Thus, giraffes are not susceptible to lymphoedema or venous diseases even though they may be on their feet 24 hours a day. circaid has incorporated this concept into its products creating solutions for an increased patient compliance and a better quality of life.

The circaid founder's wife suffered from lymphoedema for years without finding a successful treatment. When her husband – an engineer and inventor – saw the pain his wife was in, he knew he had to find a solution. The result was the first patented circaid legging (short for circulation aid) inspired by the inelastic skin giraffes have. It literally put his wife back on her feet to resume a normal and active life. This core technology would evolve into circaid products.



circaid® features

Overview of circaid characteristics.



Built-In-Pressure system

To set and control the correct therapeutic level of pressure.



Breathe-O-Prene®

Breathable, flexible and comfortable material for best wearing comfort.



Juxtaposed band system

Ensures a perfect fit as the straps can be individually adjusted while on the limb.



Variety

Wide range of styles and sizes available.

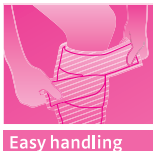

Easy handling

Easy donning and doffing promotes patient empowerment.



Inelastic

Inelastic giraffe skin – core technology of all circaid products.





circaid[®] **Built-In-Pressure** **system (BPS) –** **patented technology***

circaid inelastic compression garments are engineered with the ability to be set to precise compression ranges with a graduated compression profile from the ankle up the leg.

The user-friendly design of the circaid Built-In-Pressure system (BPS) enables patients to achieve the necessary compression ranges needed for the treatment and management of chronic venous disease.

With the circaid Built-In-Pressure system (BPS) guide card patients are able to set their prescribed compression range while donning their garment and to readjust the compression range during the day as needed. Therefore, the appropriate compression range is ensured throughout the period of wear. Simultaneously, it is very simple to verify the correct range of applied pressure.

* patented within the USA



circaid[®] juxtafit[®] premium leg garments

High quality inelastic compression garments
for the lower and upper leg.

Indications

- Mild to severe lymphoedema
- For patients who are unable to apply medical compression stockings

Product features

- High quality band fasteners for a longer product life span
- Guaranteed compression profile
- BPS to set and control the correct therapeutic pressure range
- Garment straps can be individually readjusted while on the limb
- Anti-odour and anti-microbial fabric
- Latex free for skin-friendly wearing comfort
- Sustained compression for up to 24 hours a day if required

Benefits for your patients

- Promotes self-management:
instantly adjustable
- Promotes patient empowerment:
easy donning and doffing process
- Promotes a better quality of life:
removable for bathing and skin care
- Promotes normal range of movement

Your benefits

- Time-saving application compared to bandages
- Cost-effective (reusable, less time) solution compared to bandages
- Minimal education required

Variants

- Lower leg: available in 8 sizes (S – XXL, M / L / XL extra wide) and 2 lengths (short, long)
- Also available as made-to-measure for lower leg, knee, upper leg and whole leg

Adjustable compression

20 – 50 mmHg

Product features

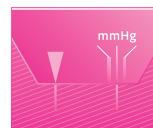

Built-In-Pressure

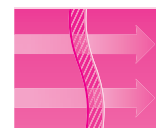

Breathe-O-Prene



Variety



Juxtaposed band



Easy handling



Inelastic

Colours

S = Standard

M = Made-to-measure



circaid® juxtafit® premium leg garments

High quality inelastic compression garments
for the lower and upper leg.

Your order includes

- 1 inelastic adjustable compression garment
- 1 pair of circaid undersleeves lower leg silver
- 1 circaid cover up
- 1 circaid power added compression band (pac band)
- 1 pair of circaid compression anklets
- 1 circaid Built-In-Pressure system (BPS) guide card



circaid juxtafit premium lower leg





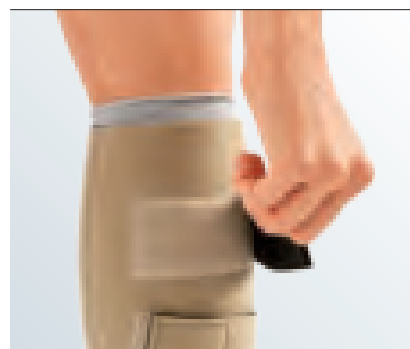







circaid juxtafit premium lower leg



circaid juxtafit premium lower leg
band fasteners with landing straps

circaid® juxtafit® premium

Styles - standard	AD	AD
		
Size / Art. No.	short	long
S	JU35702	JU35002
M	JU35703	JU35003
L	JU35704	JU35004
XL	JU35705	JU35005
XXL	JU35706	JU35006
M extra wide	JU35713	JU35013
L extra wide	JU35714	JU35014
XL extra wide	JU35715	JU35015

Styles - made-to-measure	AD	AD	AF	AF	AG	AG	DF	DG	EG
									
	lower leg	lower leg with attached ankle foot wrap	lower leg with knee	lower leg with knee and attached ankle foot wrap	whole leg	whole leg with attached ankle foot wrap	knee	upper leg with knee	upper leg
Size / Art. No.	made-to-measure JU25000	made-to-measure JU22000	made-to-measure JU26000	made-to-measure JU23000	made-to-measure JU27000	made-to-measure JU24000	made-to-measure JU28000	made-to-measure JU29000	made-to-measure JU2E000

circaid® juxtafit® premium lower leg

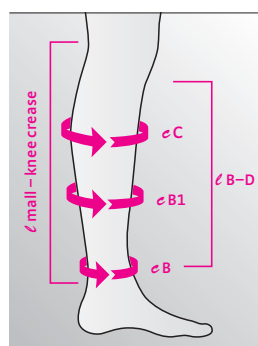

Circumferences in cm	S	M	M - X	L
eC	30 - 38	36 - 43	43 - 50	41 - 48
eB1	20 - 28	25 - 33	33 - 40	30 - 38
eB	15 - 23	20 - 28	20 - 28	25 - 33
	L - X	XL	XL - X	XXL
eC	48 - 56	41 - 51	51 - 61	53 - 64
eB1	38 - 46	33 - 41	41 - 51	43 - 53
eB	25 - 33	30 - 38	30 - 38	33 - 41

Actual garment length in cm	Short	Long
eB - D	28	36
Sizing measurement	Short	Long
e mall - knee crease	< 36	> 36

All garments contain the circaid Built-In-Pressure system (BPS).



circaid[®] juxtafit[®] essentials leg garments

Inelastic compression garments for the lower and upper leg.

Indications

- Mild to severe lymphoedema
- For patients who are unable to apply medical compression stockings

Product features

- Guaranteed compression profile
- BPS to set and control the correct therapeutic pressure range
- Garment straps can be individually readjusted while on the limb
- Anti-odour and anti-microbial fabric
- Latex free for skin-friendly wearing comfort
- Sustained compression for up to 24 hours a day if required

Benefits for your patients

- Promotes self-management: instantly adjustable
- Promotes patient empowerment: easy donning and doffing process
- Promotes a better quality of life: removable for bathing and skin care
- Promotes normal range of movement

Your benefits

- Time-saving application compared to bandages
- Cost-effective (reusable, less time) solution compared to bandages
- Minimal patient education required

Variants

- Upper leg with knee: available in 6 sizes (XXS – XL) and 3 lengths (extra short, short, long)
- Lower leg: available in 8 sizes (S – XXL, M / L / XL extra wide) and 2 lengths (short, long)

Adjustable compression

20 – 50 mmHg

Product features



Built-In-Pressure

Breathe-O-Prene



Variety

Juxtaposed band



Easy handling

Inelastic

Colours

S = Standard

M = Made-to-measure



M
Sand

circaid® juxtafit® essentials leg garments

Inelastic compression garments for the lower and upper leg.

Your order for circaid juxtafit essentials lower leg includes

- 1 inelastic adjustable compression garment
- 1 pair of circaid undersleeves lower leg lycra
- 1 circaid cover up
- 1 circaid power added compression band (pac band)
- 1 pair of circaid compression anklets
- 1 circaid Built-In-Pressure system (BPS) guide card

Your order for circaid juxtafit essentials upper leg with knee includes

- 1 inelastic adjustable compression garment
- 1 pair of circaid undersleeves whole leg lycra
- 1 circaid cover up
- 1 circaid Built-In-Pressure system (BPS) guide card

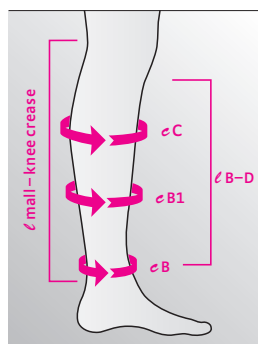

circaid® juxtafit® essentials lower leg

Circumferences in cm	S	M	M - X	L
eC	30 - 38	36 - 43	43 - 50	41 - 48
eB1	20 - 28	25 - 33	33 - 40	30 - 38
eB	15 - 23	20 - 28	20 - 28	25 - 33
	L - X	XL	XL - X	XXL
eC	48 - 56	41 - 51	51 - 61	53 - 64
eB1	38 - 46	33 - 41	41 - 51	43 - 53
eB	25 - 33	30 - 38	30 - 38	33 - 41

Actual garment length in cm	Short	Long
eB - D	28	36
Sizing measurement	Short	Long
e heel - knee crease	< 36	> 36

All garments contain the circaid Built-In-Pressure system (BPS).

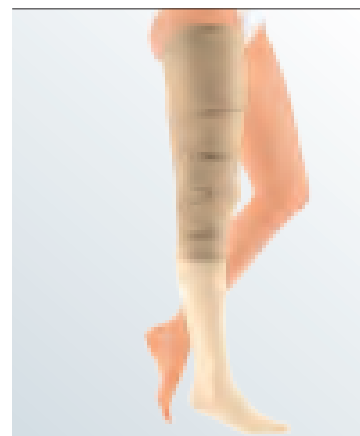

circaid juxtafit essentials upper leg with knee and sock





circaid juxtafit essentials lower leg (with pac band)





circaid juxtafit essentials lower leg

circaid® juxtafit® essentials lower leg

Styles - standard	AD	AD
		
Size / Art. No.	short	long
S	JU25702	JU25002
M	JU25703	JU25003
L	JU25704	JU25004
XL	JU25705	JU25005
XXL	JU25706	JU25006
M extra wide	JU25713	JU25013
L extra wide	JU25714	JU25014
XL extra wide	JU25715	JU25015

circaid® juxtafit® essentials upper leg with knee

Styles	DG	DG	DG	
				
Size / Art. No.	x-short	short	long	
Left	XXS	JU2978Z	JU2973Z	JU2903Z
	XS	JU29781	JU29731	JU29031
	S	JU29782	JU29732	JU29032
	M	JU29783	JU29733	JU29033
	L	JU29784	JU29734	JU29034
	XL	JU29785	JU29735	JU29035
Right	XXS	JU2979Z	JU2974Z	JU2904Z
	XS	JU29791	JU29741	JU29041
	S	JU29792	JU29742	JU29042
	M	JU29793	JU29743	JU29043
	L	JU29794	JU29744	JU29044
	XL	JU29795	JU29745	JU29045

circaid® juxtafit® essentials upper leg with knee

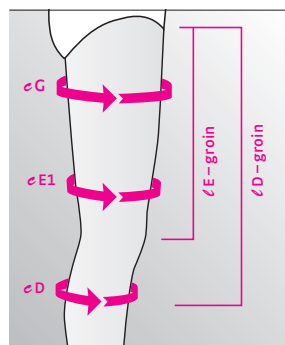

Circumferences in cm	XXS	XS	S	M	L	XL
eG	40-52	46-62	54-70	60-80	69-90	77-101
eE1*	32-42	37-48	42-55	50-65	58-76	66-87
eD	23-30	27-35	31-41	35-46	40-52	44-58

Actual garment length in cm	X-Short	Short	Long
lD - groin	35	45	55
Sizing measurement	X-Short	Short	Long
lE - groin	< 25	25-35	> 35

All garments contain the circaid Built-In-Pressure system (BPS).
* 5 cm above the patella

circaid® ankle foot options

Additional compression for the foot and ankle.

circaid® power added compression band (pac band)

- circaid power added compression band targets the arch of the foot and around the malleoli
- Used in combination with the circaid compression ankle for added compression
- Can be trimmed to fit almost every foot shape
- Lightweight and breathable material
- Available in standard and large



Breathe-O-Prene



Variety



Easy handling

Circumferences in cm

	Standard	Large
eB	19–27	25–50
eH	19–36	22–41

Art.-No.

Size

JU5P001	Standard
JU5P002	Large

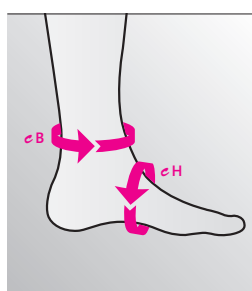

circaid® single band ankle foot wrap (afw)

- Gives compression to the foot and ankle
- Suitable for all foot sizes and shapes
- Available in standard only
- Ideal for individual bandaging of the foot



Measurements

Width	7,6 cm
Length	203 cm

Art.-No.

JU5Q001



circaid® juxtafit® premium interlocking ankle foot wrap (afw)

- Provides ankle and foot coverage
- Interlocking heel band for foot length adjustment
- Heel band offers targeted compression to the heel and ankle
- Available in 3 sizes (S, M, L)



Measurements in cm

	S	M	L
∠A-Y	>9	>9	>9
eB	<36	<36	<41
eH	19-24	24-29	29-34
∠A	13-25	13-25	13-25

Art.-No. Size

JU31002	S
JU31003	M
JU31004	L

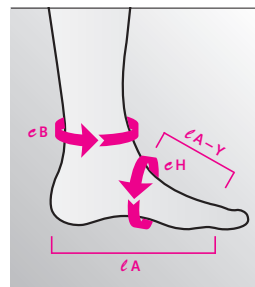

circaid® juxtafit® premium ankle foot wrap (afw)

- Provides ankle and foot coverage
- Instantly adjustable
- Available in 3 sizes (S, M, L) and made-to-measure



Breathe-O-Prene



Variety



Easy handling

Measurements in cm

	S	M	L
cA-Y	>9	>9	>9
cB	<36	<36	<41
cH	19-24	24-29	29-34
cA	>16	>16	>16

Art.-No. Size

JU3W002	S
JU3W003	M
JU3W004	L
JU2W000	Made-to-measure

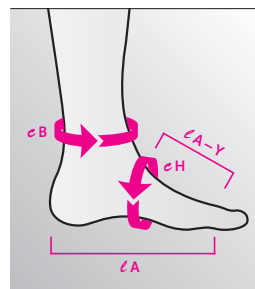

circaid® compression anklet

- Provides compression to the foot and ankle
- Can be worn in combination with another foot option
- Available in standard and large



Variety



Easy handling

Circumferences in cm

	Standard	Large
cB	19-27	25-50
cH	19-36	22-41

Art.-No. Size

JU51001	Standard
JU51002	Large

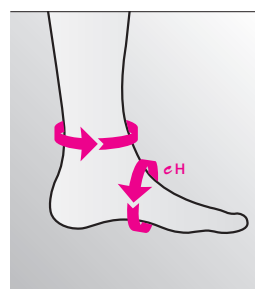
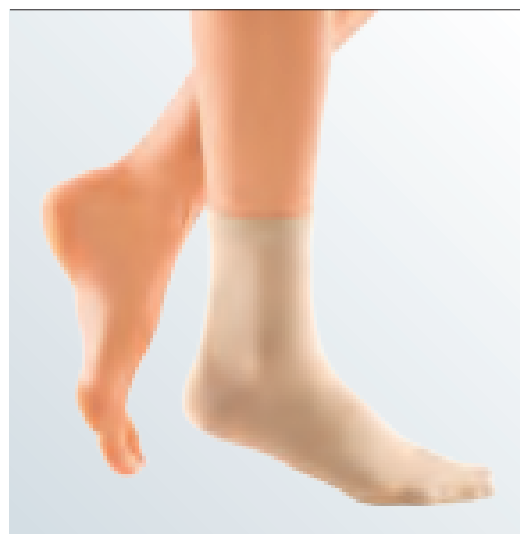





circaid[®] juxtafit[®] essentials arm

Inelastic compression garment for the arm.

Indications

- Mild to severe lymphoedema
- For patients who are unable to apply medical compression armsleeves

Product features

- Guaranteed compression profile
- BPS to set and control the correct therapeutic pressure range
- Garment straps can be individually readjusted while on the limb
- Anti-odour and anti-microbial fabric
- Latex free for skin-friendly wearing comfort
- Sustained compression for up to 24 hours a day if required

Benefits for your patients

- Promotes self-management: instantly adjustable
- Promotes patient empowerment: easy donning and doffing process
- Promotes a better quality of life: removable for bathing and skin care
- Promotes normal range of movement

Your benefits

- Time-saving application compared to bandages
- Cost-effective (reusable, less time) solution compared to bandages
- Minimal education required

Variants

- 6 standard sizes (sizes 1 – 6) and 3 lengths (extra short, short, long)
- Also available as made-to-measure

Adjustable compression

10 – 40 mmHg

Product features

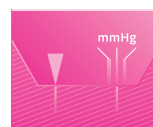

Built-In-Pressure

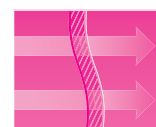

Breathe-O-Prene



Variety



Juxtaposed band



Easy handling



Inelastic

Colours

S = Standard

M = Made-to-measure



M
Sand

circaid[®] juxtafit[®] essentials arm

Inelastic compression garment for the arm.

Your order includes

- 1 inelastic adjustable compression garment
- 1 circaid cover up arm
- 1 circaid Built-In-Pressure system (BPS) guide card
- 1 elbow band



circaid juxtafit essentials arm

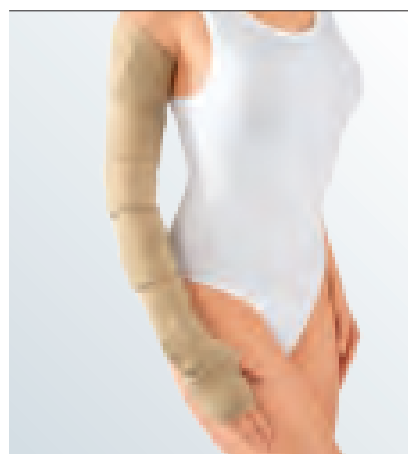



circaid juxtafit essentials arm with
circaid juxtafit essentials hand wrap



circaid juxtafit essentials hand wrap

circaid® juxtafit® essentials arm

Styles		CG	CG	CG
				
Size / Art. No.		x-short	short	long
Left	1	JU2A781	JU2A731	JU2A031
	2	JU2A782	JU2A732	JU2A032
	3	JU2A783	JU2A733	JU2A033
	4	JU2A784	JU2A734	JU2A034
	5	JU2A785	JU2A735	JU2A035
	6	JU2A786	JU2A736	JU2A036
Right	1	JU2A791	JU2A741	JU2A041
	2	JU2A792	JU2A742	JU2A042
	3	JU2A793	JU2A743	JU2A043
	4	JU2A794	JU2A744	JU2A044
	5	JU2A795	JU2A745	JU2A045
	6	JU2A796	JU2A746	JU2A046

circaid® juxtafit® essentials arm

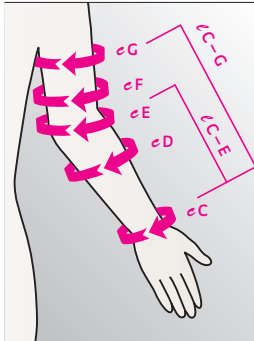

Circumferences in cm						
	1	2	3	4	5	6
eG	28-32	30-34	32-37	35-40	38-44	42-48
eF	26-30	28-32	30-35	33-38	36-41	39-45
eE	25-28	27-30	29-32	31-34	33-36	36-40
eD	23-26	25-28	27-30	29-32	31-34	33-37
eC	15-17	17-19	19-21	21-23	23-25	25-28

Actual garment length in cm	X-Short	Short	Long
lC-G	38	43	48
Sizing measurement	X-Short	Short	Long
lC-E	<22	22-25	>25

All garments contain the circaid Built-In-Pressure system (BPS).

circaid® juxtafit® essentials hand options

Additional compression for the hand.

circaid® juxtafit® essentials hand wrap

- Compresses the hand from the wrist to the base of the fingers
- Adjustable for additional pressure on the dorsum of the hand
- Simple handling, ideal for self-care
- Cost-effective solution for oedema management
- Adjustable and available in 5 sizes (XS–XL) and left/right versions
- Exclusively in standard sizes

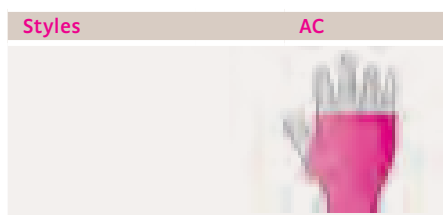

Size / Art. No.	hand wrap	
Left	XS	JU2B031
	S	JU2B032
	M	JU2B033
	L	JU2B034
	XL	JU2B035
Right	XS	JU2B041
	S	JU2B042
	M	JU2B043
	L	JU2B044
	XL	JU2B045

Circumferences in cm	XS	S	M	L	XL
	eB Palm	14 – 17	17 – 20	20 – 23	23 – 26

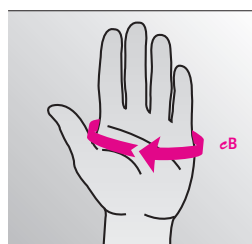

circaid® juxtafit® essentials glove

- Compresses the hand, including fingers
- Only available as made-to-measure

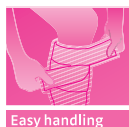

Styles	AC
 <p>glove</p>	
Size / Art. No.	made-to-measure JU2B000



circaid® juxtafit® essentials open palm glove

- Alternative to circaid juxtafit essentials glove
 - Easier donning
 - Recommended for larger hands



Styles	AC
 <p>open palm glove</p>	
Size / Art. No.	made-to-measure JU2F000



circaid® juxtafit® essentials glove with dorsum strap

- Perfect addition to the circaid juxtafit essentials glove
- Independently adjustable to provide additional compression to the dorsum of the hand
- Only available as made-to-measure



Styles	AC	AC
 <p>glove with dorsum strap</p>		 <p>separate dorsum strap</p>
Size / Art. No.	made-to-measure JU2L000	made-to-measure JU2C000





circaid® accessories

circaid® undersleeves and socks

For arm, whole leg and lower leg.

Can be worn directly against the skin underneath circaid products to provide added comfort.

- Note: does not provide therapeutic compression

Arm versions

- circaid undersleeve arm lycra with thumb hole
- circaid undersleeve arm silver with thumb hole

Standard size	Art.-No.	Type
AG arm	JULV009	Lycra
with thumb opening	JUSV009	Silver

Leg versions

- circaid undersleeves (footless)
 - lower leg lycra
 - whole leg lycra
 - lower leg silver
 - whole leg silver
- circaid socks (with foot portion)
 - lower leg lycra
 - whole leg lycra
 - lower leg silver
 - whole leg silver
 - lower leg cotton terry
(extra thick for maximum comfort)
 - whole leg cotton terry
(extra thick for maximum comfort)

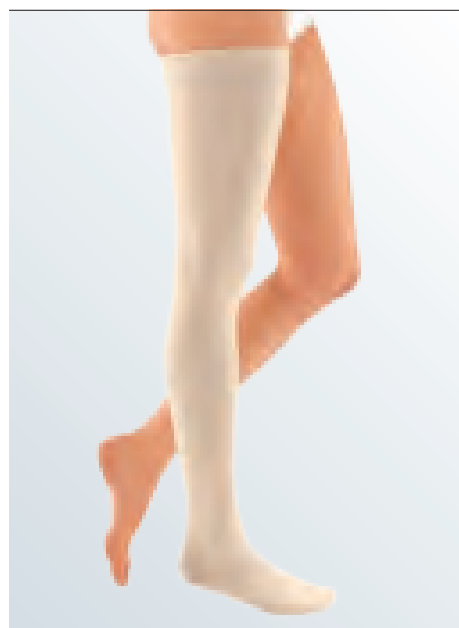

circaid sock whole leg lycra



circaid undersleeve lower leg silver

Standard size	Art.-No.	Type	Style
Socks	JULT709	Lycra	AD
	JUST709	Silver	AD
	JUCT709	Cotton	AD
	JULT009	Lycra	AG
	JUST009	Silver	AG
	JUCT009	Cotton	AG
Undersleeves	JULS709	Lycra	BD
	JUSS709	Silver	BD
	JULS009	Lycra	BG
	JUSS009	Silver	BG

circaid® cover up

Silky oversleeve for circaid garments.

Can be worn over circaid arm and leg garments.

- Prevents the garments from snagging on clothing or bedding
- Gives inelastic compression garments a refined look
- Available in black, beige and pink (for arm only)
- Note: does not provide therapeutic compression

Styles arm

Standard size	Art.-No.	Colour	Size
CG	JU5U0B2	Beige	S
	JU5U0B4	Beige	L
	JU5U0P2	Pink	S
	JU5U0P4	Pink	L
	JU5U0A2	Black	S
	JU5U0A4	Black	L
	JU5U000		Made-to-measure

Styles leg

Standard size	Art.-No.	Colour	Size
BD	JU5C7B2	Beige	S
	JU5C7B4	Beige	L
	JU5C7A2	Black	S
	JU5C7A4	Black	L
	JU5C700		Made-to-measure
BG	JU5C0B2	Beige	S
	JU5C0B4	Beige	L
	JU5C0A2	Black	S
	JU5C0A4	Black	L
	JU5C000		Made-to-measure

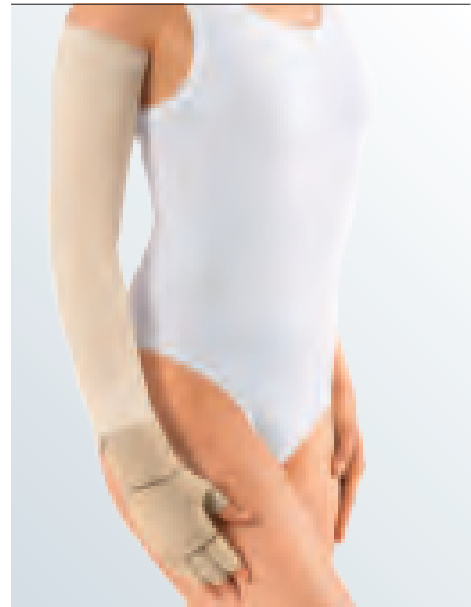

circaid cover up arm



circaid cover up lower leg

circaid® juxtafit® premium shelf strap

Additional support and coverage.

- Offers additional support and coverage to shelves and lobules that may be present on the limb
- Covers potential gaps that may appear in between the straps

Art.-No.	Size
JU2Q001	S
JU2Q002	L
JU2Q000	Made-to-measure



circaid juxtafit premium shelf strap

circaid® non slip cloth

Prevents the garment from sliding.

- Aids in preventing the garment from sliding
- Can be trimmed to fit most limbs (original size is 46 cm x 152 cm)
- Note: does not provide therapeutic compression

Art.-No.	Size in cm
JU5R002	46 x 152



circaid non slip cloth

circaid® further products

circaid® graduate arm

**Inelastic padded compression system
for the arm.**

Indications

- Mild to severe lymphoedema
- For patients who are unable to apply medical compression armsleeves

Product features

- Foam garment ensures smooth comfortable compression for the entire arm including a hand cover
- Garment colours available in
 - Exterior: Black, beige, red, turquoise
 - Interior: Beige, red, turquoise
- Only available as made-to-measure

Style	Art.-No.	Size
CG	JU7A000	Made-to-measure



circaid graduate arm

circaid® graduate lower leg

**Inelastic padded compression system
for the lower leg.**

Indications

- Mild to severe lymphoedema
- For patients who are unable to apply medical compression stockings

Product features

- Foam garment ensures smooth comfortable compression for the lower leg including the foot
- Garment colours available in
 - Exterior: Black, beige, red, turquoise
 - Interior: Beige, red, turquoise
- Only available as made-to-measure

Style	Art.-No.	Size
BD	JU82000	Made-to-measure



circaid graduate lower leg

circaid® graduate whole leg

Inelastic padded compression system for the whole leg.

Indications

- Mild to severe lymphoedema
- For patients who are unable to apply medical compression stockings

Product features

- Foam garment ensures smooth comfortable compression for the entire leg including the foot
- Garment colours available in
 - Exterior: Black, beige, red, turquoise
 - Interior: Beige, red, turquoise
- Only available as made-to-measure

Style	Art.-No.	Size
AG	JU84000	Made-to-measure



circaid graduate whole leg

What is included in your order?

Standard sizes					
	1 inelastic adjustable compression garment	1 pair of circaid undersleeve lower leg	1 pair of circaid undersleeve whole leg	1 circaid cover up lower leg	1 circaid cover up whole leg
circaid juxtafit premium lower leg	•	•		•	
circaid juxtafit essentials lower leg	•	•		•	
circaid juxtafit essentials upper leg with knee	•		•		•
circaid juxtafit essentials arm	•				

Made-to-measure (required foot option has to be indicated for each order) **					
circaid juxtafit premium lower leg *	•	•		•	
circaid juxtafit premium lower leg with knee *	•		•		•
circaid juxtafit premium knee	•		•		•
circaid juxtafit premium upper leg	•	•	•		•
circaid juxtafit premium upper leg with knee	•	•	•		•
circaid juxtafit premium whole leg *	•	•	•		•
circaid juxtafit essentials arm	•				
circaid graduate lower leg	•	•		•	
circaid graduate whole leg	•		•		•
circaid graduate arm	•				

* Provided as needed based on the patient measurements

** If you do not indicate a foot piece for mtm orders you will automatically receive a circaid pac band with anklets

1 circaid cover up arm	1 circaid juxtafit premium shelf straps*	1 circaid non slip cloth	1 circaid power added compression band (pac band)	1 pair of circaid compression anklets	1 circaid Built-In-Pressure system (BPS) guide card
			•	•	•
			•	•	•
					•
•					•
	•		•**	•**	•
	•		•**	•**	•
	•				•
	•	•			•
	•	•			•
	•	•	•**	•**	•
•	•				•
					•
					•
•					•

Undersleeves and socks

- Silver for circaid juxtafit premium
- Lycra for circaid juxtafit essentials





Service

On the following pages we have compiled all the relevant information you will need for ordering our products. “medi. I feel better”.

Correct fitting of round knit compression stockings

Note: please take the measurements on the inside of the leg except for ℓG



eA, lA, lZ
Take circumferential measurement **eA** just behind the joint at the base of the toes where the little toe begins. **The length of the foot for open toe stockings** is determined by the length measurement **lA** which is measured from the ridge of the heel to measurement point **eA**. **The length of the foot for closed toe stockings** is measured from the ridge of the foot to the tips of the toes. (**lZ**-measurement)



eY
Take the circumferential measurement **eY**, around the heel and the instep, with the foot in maximum dorsal extension.

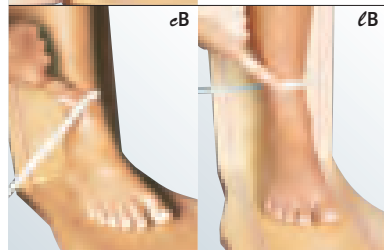

eB, lB
Take the circumferential measurement **eB** and length measurement **lB** at the narrowest circumference of the leg below the knee, directly above the ankle. This measurement above the ankle bones is especially important for selecting the stocking size, because the pressure here will be 100 %.

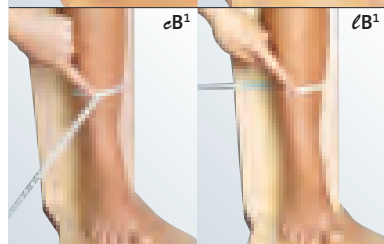

eB¹, lB¹
The circumferential measurement **eB¹** and the length measurement **lB¹** are at the point where the calf begins, or at the transition point to the Achilles tendon.

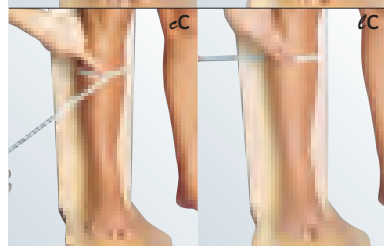

eC, lC
Take the **eC** and **lC** length measurements at the widest circumference of the calf.

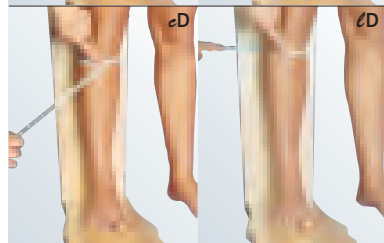

eD, lD
Take the circumference **eD** and length **lD** measurements about two fingerbreadths below the hollow of the knee at the level of the head of the fibula.

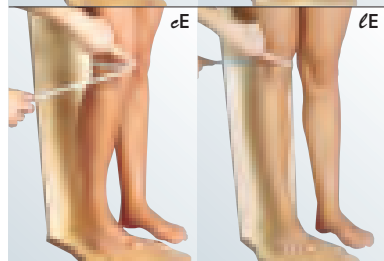

eE, lE
The circumferential measurement **eE** is the circumference of the knee. Measure it below the hollow of the knee and all the way round, in the middle of the kneecap. The leg should be slightly bent. Take the length measurement **lE** when the leg is straight.



eF, lF
Circumferential measurement **eF** and length measurement **lF** are located where the inner thigh muscle begins or in the middle of the thigh.



eG, lG
Take the **eG** and length measurement **lG** about 3 cm below the crotch.

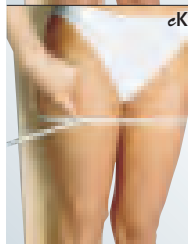

eK
Take the circumferential measurement **eK** at the height of the g measurement, around both legs.



eH, lH
Take the circumferential measurement **eH** at hip level at the widest point of the buttocks.



eT, lT
Take the circumferential measurement **eT** round the waist.



Front panty top length

Measure from the crotch to the waist. It is however more comfortable for the patient if you go 3cm to the side of the crotch and measure the panty top length from there.



Back panty top length

Measure from the gluteal fold to the waist. If the patient requests a longer or shorter panty top, you must measure to the length the patient requests. The "waist" point is only the standard length.

Round knit – Order for Made-to-measure compression stockings / pantyhose

Fax order to medi • Telefax +49 921 912-781

medi GmbH & Co. KG
Medicusstraße 1
95448 Bayreuth
Germany
T +49 921 912-0
F +49 921 912-781
export@medi.de
www.medi.de/en

Customer No. _____

Date _____

Commission / Made-to-measure No. _____

Quantity piece(s) pair(s) pants

Sender / Date / Stamp _____

Foot Requirements

- Foot length open toe (ℓA)
(heel to ball eA): _____ cm
- Foot length closed toe (ℓZ)
(heel to toe): _____ cm
- Soft toe

Colour

Topbands mediven comfort, mediven forte

- Multifunctional topband (MfB)
- Silicone topband (NoB)
- Silicone topband with motif (NoM)
- Sensitive topband (SeB)
- Tricot border (except comfort)

Topbands mediven elegance, mediven plus

- Topband platinum (TBp)
- Topband sensitive (TBs)
- Topband extra (TBe)
- Topband basic (TBb)
- Tricot border

Waist attachment

only plus and forte

- left right

Heel ℓT: _____ cm

Waist circumference eT: _____ cm

Special requests

Circumferences left leg / cm		Circumferences right leg / cm		Length panty section cm
		please specify length of panty section		front
				back
		eT	eH	ℓT
				Lengths leg
eG		eK	eG	ℓG
eF		eF	eF	ℓF
eE		eE	eE	ℓE
eD		eD	eD	ℓD
eC		eC	eC	ℓC
eB ¹		eB ¹	eB ¹	ℓB ¹
eB		eB	eB	ℓB
eY		eY	eY	
eA		eA	eA	
ℓA	ℓA	Foot length		ℓA
ℓZ	ℓZ			ℓZ

Models	CCL	CCL	CCL	Lengths					
				AD	AF	AG	AT	AT / U	AT / H
Please mark with a cross:	1	2	3						
mediven elegance			■						■
mediven comfort				■				■	
mediven plus									
mediven forte	■								

All measurements are body measurements! The person placing the order is liable for incorrect measurements. Made-to-measure garments cannot be returned.
All made-to-measure orders must be placed in writing.

Correct fitting of flat knit compression stockings

Before taking measurements for compression stockings with seams, any swelling should be reduced as much as possible. Circumference and length measurements are taken in a distal to proximal direction. The measuring points on the leg must be marked so that the circumference and length measurements are taken at the same location. For lymphatic compression stockings, some measurements will be performed with tension applied. A trained fitter fibroses, will provide the correct compression, which depends on oedema and tissue related characteristics, sensitivity to pain, fibroses, oedema sites, mobility, and the patient's strength.

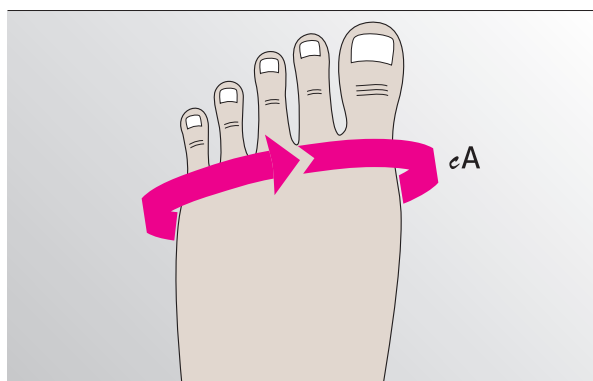

1. Foot circumference

- Leg is resting relaxed on a horizontal support
- During this measurement, the foot is relaxed, not held in a 90° position

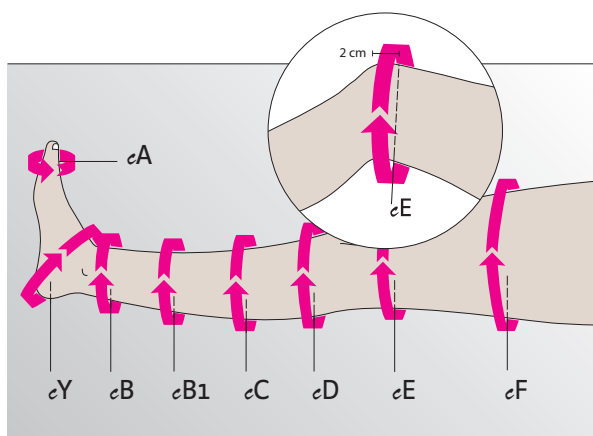

2. Leg circumference

- Leg is lying in a relaxed position on a support.
- For circumference measurement cY , flex foot in dorsal direction to maximum extent
- Measure the remaining circumferences up to cF with the leg in a relaxed position
- For circumference measurement cE , bend knee slightly
- Mark measuring points

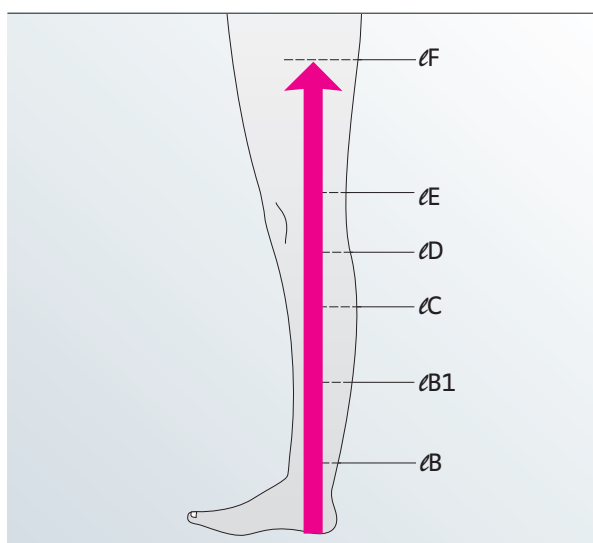

3. Leg length

Proximal length measurements need to be taken along the inside of the leg while the patient is standing.

medi uses the measurement method according to the guidelines of the Federal Academy for Orthopaedic Technology in Dortmund.

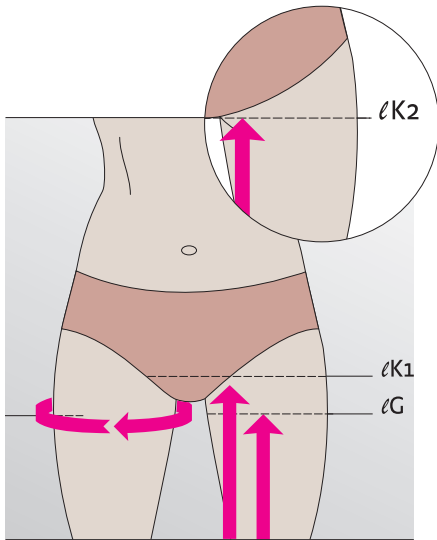

4. Border on thigh

- Measure circumference ℓG at the widest part on the thigh / below crotch
 - Measure length ℓG along the leg with patient standing up
 - Measure ℓK_2 from ground to gluteal fold along body with patient standing up \triangleq **posterior leg length**
 - Measure ℓK_1 from ground to symphysis along body with patient standing up \triangleq **anterior leg length**
- (Difference between ℓK_1 and $\ell K_2 \triangleq$ high front / low back)

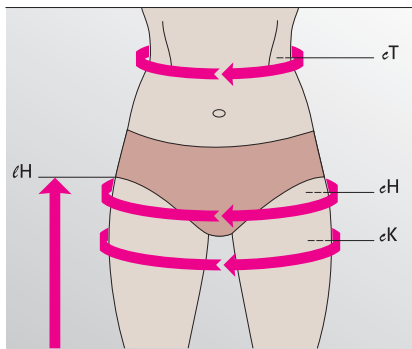

5. Waist / hip circumference / length

- Measure circumference ℓK with patient standing up at the widest section around both thighs below the gluteal fold
- Measure circumference ℓH with patient standing up at the widest section of the hips
- Measure circumference ℓT with patient standing up at the waist or the desired border
- Measure length ℓH along body up to desired height = Exterior leg length

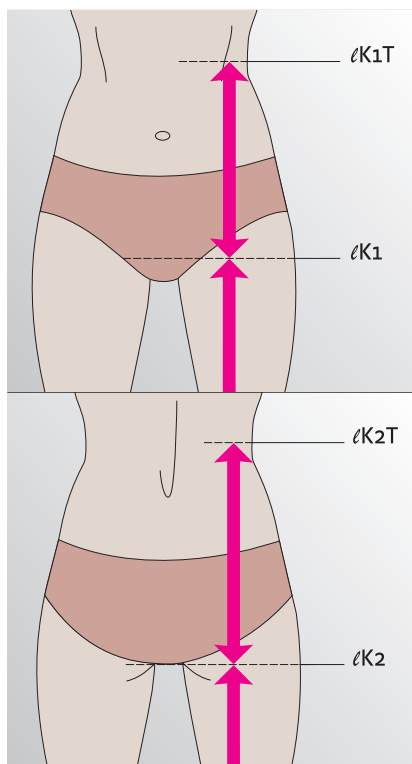

6. Waist / hip lengths

- Measure anterior pelvic height ℓK_{1T} along body from crotch (symphysis) to waist or desired height
- Measure posterior pelvic height ℓK_{2T} along body from gluteal fold to waist or desired height

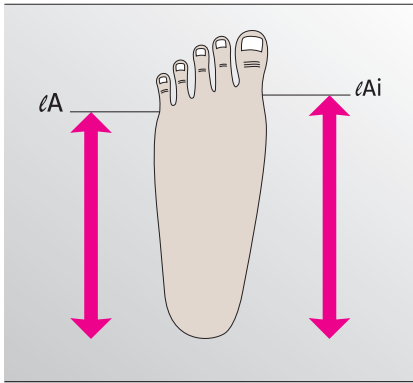

7. Foot length

Open toe / oblique border

Measure lengths on the inside and outside of weight-bearing foot.

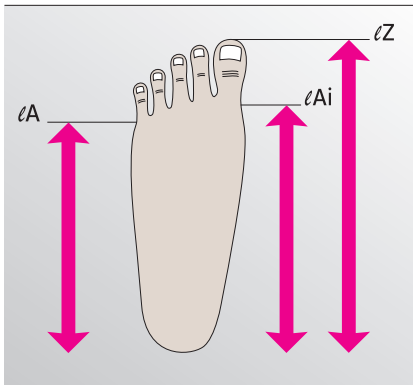

8. Foot length

Closed toe / oblique border

Measure lengths on inside, outside and entire weight-bearing foot.

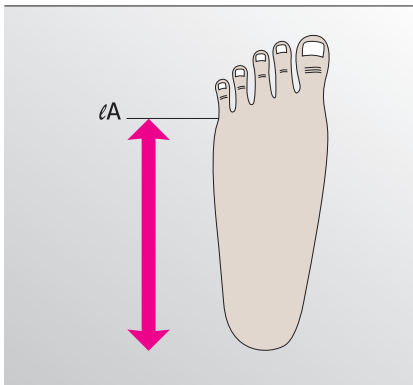

9. Foot length

Open toe / straight border

Measure length on outside of weight-bearing foot.

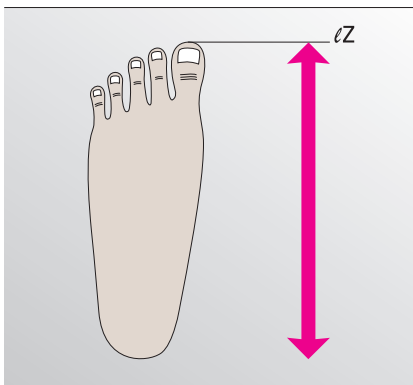

10. Foot length

Closed toe / straight border

Measure length of entire, weight-bearing foot. Generally, this design is made to allow a 6 cm long toe area.

- Estimate
- Order

Fax order to medi • Telefax +49 921 912-781

medi

Customer name: _____

Customer No.: _____ Delivery address: _____

Commission: _____

Stamp: _____

Delivery date: (client) _____ Order date: _____

Signature: _____

mediven® compression garments flat-knitted with seam

Circumferences left		Circumferences right	
normal	Tight tape measure	Tight tape measure	normal
<input type="text"/>	eT <input type="text"/>	<input type="text"/>	eT <input type="text"/>
<input type="text"/>	eH <input type="text"/>	<input type="text"/>	eH <input type="text"/>
<input type="text"/>	eK <input type="text"/>	<input type="text"/>	eK <input type="text"/>
<input type="text"/>	eG <input type="text"/>	<input type="text"/>	eG <input type="text"/>
<input type="text"/>	eF <input type="text"/>	<input type="text"/>	eF <input type="text"/>
<input type="text"/>	eE <input type="text"/>	<input type="text"/>	eE <input type="text"/>
<input type="text"/>	eD <input type="text"/>	<input type="text"/>	eD <input type="text"/>
<input type="text"/>	eC <input type="text"/>	<input type="text"/>	eC <input type="text"/>
<input type="text"/>	eB ₁ <input type="text"/>	<input type="text"/>	eB ₁ <input type="text"/>
<input type="text"/>	eB <input type="text"/>	<input type="text"/>	eB <input type="text"/>
<input type="text"/>	eY <input type="text"/>	<input type="text"/>	eY <input type="text"/>
<input type="text"/>	eA <input type="text"/>	<input type="text"/>	eA <input type="text"/>

Lengths	
left	right
<input type="text"/> eK ₁ T	<input type="text"/> eK ₂ T
<input type="text"/> eH	<input type="text"/> eH
<input type="text"/> eK ₁	<input type="text"/> eK ₂
<input type="text"/> eG	<input type="text"/> eG
<input type="text"/> eF	<input type="text"/> eF
<input type="text"/> eE	<input type="text"/> eE
<input type="text"/> eD	<input type="text"/> eD
<input type="text"/> eC	<input type="text"/> eC
<input type="text"/> eB ₁	<input type="text"/> eB ₁
<input type="text"/> eB	<input type="text"/> eB

ePit of knee

<input type="text"/>	<input type="text"/>
left	right

Please specify "elliptical form" under Special request

Model	Compression CCL	1	2	3	4	Standard colours	Trend colours**	Quantity	Foot
<input type="checkbox"/> mediven sensoo (CCL 2)	Panty section	<input type="checkbox"/>	<input type="checkbox"/>	<input type="checkbox"/>	<input type="checkbox"/>	<input type="checkbox"/> Sand	<input type="checkbox"/> Cashmere	<input type="checkbox"/> pair _____	<input type="checkbox"/> closed toe
<input type="checkbox"/> mediven mondi (CCL 1, 2, 3)	Left leg	<input type="checkbox"/>	<input type="checkbox"/>	<input type="checkbox"/>	<input type="checkbox"/>	<input type="checkbox"/> Caramel	<input type="checkbox"/> Navy	<input type="checkbox"/> pcs. _____	<input type="checkbox"/> open toe
<input type="checkbox"/> mediven 550 (CCL 1, 2, 3, 4)	Right leg	<input type="checkbox"/>	<input type="checkbox"/>	<input type="checkbox"/>	<input type="checkbox"/>	<input type="checkbox"/> Black	<input type="checkbox"/> Anthracite		<input type="checkbox"/> soft toe (only mediven 550)
							<input type="checkbox"/> Aqua		<input type="checkbox"/> toe cap
							<input type="checkbox"/> medi Magenta		
							<input type="checkbox"/> Moss-green		
							<input type="checkbox"/> Cherry-red		

Variants	Standard border	optional border	Accessories	Waist	Gusset
<input type="checkbox"/> below knee (AD)	slight oblique (proximal)	<input type="checkbox"/> steep oblique <input type="checkbox"/> straight	<input type="checkbox"/> Extension to sole of foot	<input type="checkbox"/> perforated topband	<input type="checkbox"/> tricot
<input type="checkbox"/> thigh-length (AG)			<input type="checkbox"/> Y knitting mark (90° heel)		
<input type="checkbox"/> pantyhose (AT)			<input type="checkbox"/> elliptical form	<input type="checkbox"/> knitted border	<input type="checkbox"/> netting
<input type="checkbox"/> men's leotard (ATH)			<input type="checkbox"/> orientation mark at „D“ (only for AG and AT)		<input type="checkbox"/> compressive
<input type="checkbox"/> maternity panty (ATU) (only mediven 550 and mediven mondi)			<input type="checkbox"/> extra leg length (eK1 needed)		
<input type="checkbox"/> one-legged panty (ATE)			<input type="checkbox"/> _____ cm porous		
<input type="checkbox"/> BT / CT / ET / FT					

Other accessories

_____ cm topband section along oblique (Standard 15 cm)

_____ cm topband section above knee (Standard 8 cm)

_____ cm topband section at rear over seam (Standard 8 cm)

Silver "Y" to C "Y" to D "Y" to G

(only mediven mondi) left right

Lymphpad* Padding* Pocket*

left inside outside right inside outside

Attachment

profile topband (5 cm) Circumference: left _____ cm

silicone topband narrow 2.5 cm wide 5 cm right _____ cm

silicone topband with motif (5 cm)

waist attachment left right IT _____ cm

Designelemente mediven 550: Stars Ribs Pyramids

Special requests

* Please specify / draw exact area.
** Delivery period up to 10 working days

Getting fitted for flat knit toe caps

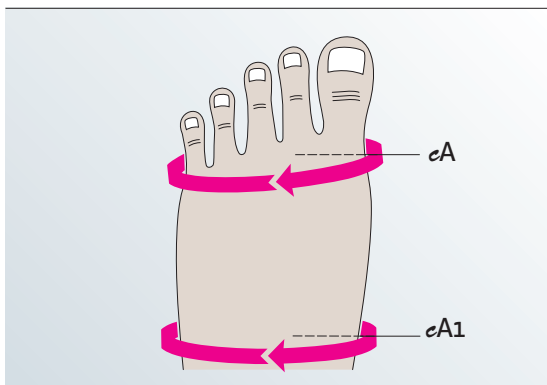

1. Foot circumference

- a) Leg is placed flat on a support
- b) Measure circumference
- c) Mark the measuring points

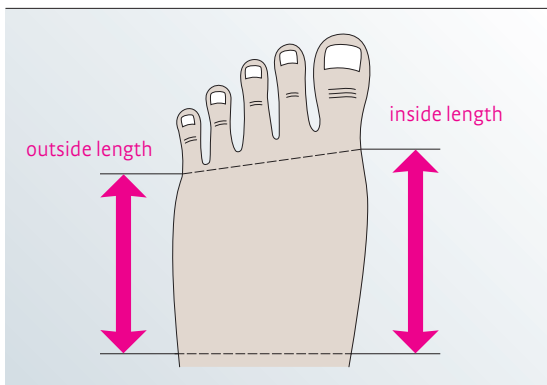

2. Foot length

- a) Proceed as in (1)
- b) Measure the length on the inside and outside of the foot
- c) Measure the distance from mark to mark (see measured circumference)

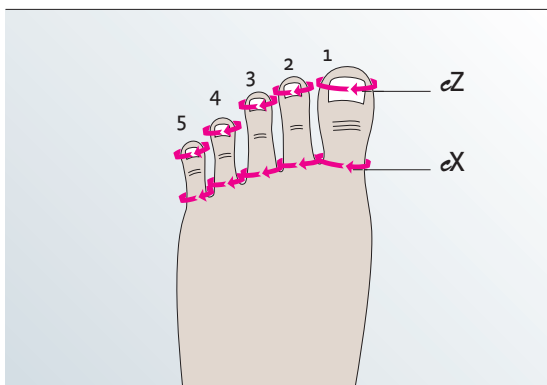

3. Toe circumference

- a) Proceed as in (1)
- b) Measure circumference cX at web area
- c) Measure the circumference cZ at the nail bed

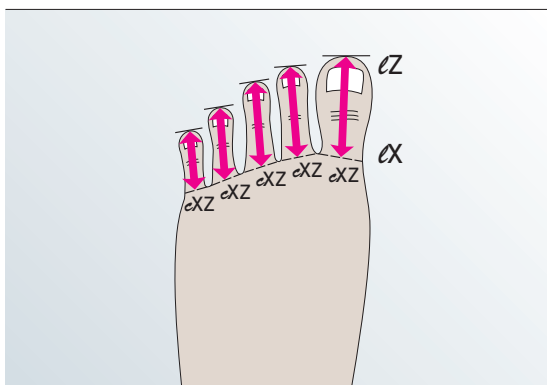

4. Toe lengths

- a) Proceed as in (1)
- b) Measure length from web to the end of the toe

medi uses the measurement method according to the guidelines of the Federal Academy for Orthopaedic Technology in Dortmund.

- Estimate
- Order

Fax order to medi • Telefax +49 921 912-781



Customer name: _____

Customer No.: _____ Delivery address: _____

Commission: _____

Stamp: _____

Delivery date: (client) _____ Order date: _____

Signature: _____

mediven® toecaps flat-knitted with seam

Circumferences and lengths left

5 4 3 2 1

ℓXZ

ℓXZ

ℓXZ

ℓXZ

ℓXZ

cZ

cZ

cZ

cZ

cZ

cX

cX

cX

cX

cX

Circumferences and lengths right

1 2 3 4 5

ℓXZ

ℓXZ

ℓXZ

ℓXZ

ℓXZ

cZ

cZ

cZ

cZ

cZ

cX

cX

cX

cX

cX

Model	Compression CCL	1	2	3	Standard colours	Trend colour*	Quantity left	Quantity right
<input type="checkbox"/> mediven mondi (CCL 1, 2)	Toe cap mediven mondi	<input type="checkbox"/>	<input type="checkbox"/>	<input type="checkbox"/>	<input type="checkbox"/> Sand <input type="checkbox"/> Caramel <input type="checkbox"/> Black	<input type="checkbox"/> Cashmere <input type="checkbox"/> medi Magenta <input type="checkbox"/> Navy <input type="checkbox"/> Moss-green <input type="checkbox"/> Anthracite <input type="checkbox"/> Cherry-red <input type="checkbox"/> Aqua	pcs. _____	pcs. _____
<input type="checkbox"/> mediven 550 (CCL 1, 2, 3)	Toe cap mediven 550	<input type="checkbox"/>	<input type="checkbox"/>	<input type="checkbox"/>				

Other accessories / left variant	Other accessories / right variant
<input type="checkbox"/> without small toe <input type="checkbox"/> with small toe <input type="checkbox"/> closed toes <input type="checkbox"/> open toes <input type="checkbox"/> separate toe cap <input type="checkbox"/> toe cap sewn to the stocking <input type="checkbox"/> toe cap seamless knitted to the stocking	<input type="checkbox"/> without small toe <input type="checkbox"/> with small toe <input type="checkbox"/> closed toes <input type="checkbox"/> open toes <input type="checkbox"/> separate toe cap <input type="checkbox"/> toe cap sewn to the stocking <input type="checkbox"/> toe cap seamless knitted to the stocking
<input type="checkbox"/> Lymphpad <input type="checkbox"/> Padding <input type="checkbox"/> Pocket Please specify position exactly! (length / width)	<input type="checkbox"/> Lymphpad <input type="checkbox"/> Padding <input type="checkbox"/> Pocket Please specify position exactly! (length / width)

Design elements mediven® 550: Stars Ribs Pyramids

Special requests

*Delivery period up to 10 working days

Correct fitting of flat knit arm compression sleeves

Before taking measurements for the armsleeve and glove, any swelling should be reduced as much as possible. At the circumferences of cC , cC_1 , and at the elbow, take measurements without applying any tension. For all other circumference measurements, it depends on how much pressure the patient can tolerate. Please always use a soft marker (e. g. a kohl pencil) to prevent damage to the skin.

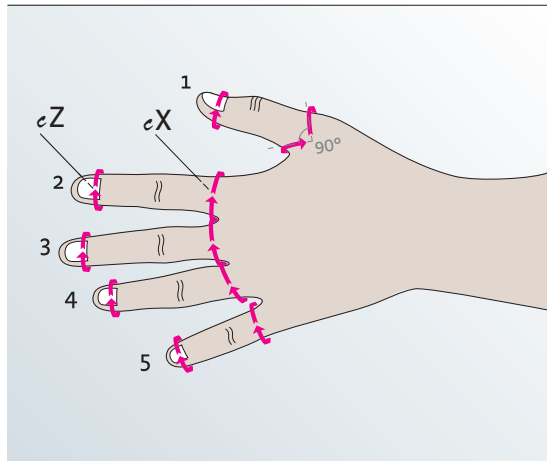

1. Finger circumference

- Hand is resting lightly on a surface with the back of the hand facing up
- Measure circumference eX at the web between fingers
- eZ is measured at the nail bed
- Mark the measuring points for length measurement

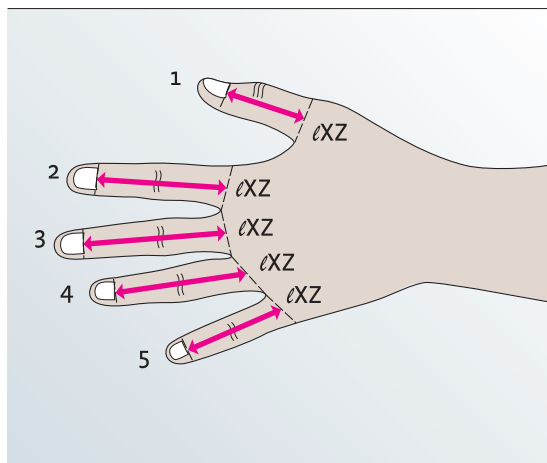

2. Finger length

- Hand is resting lightly on a surface with the palm of the hand facing up
- Length is measured from mark to mark (see "Finger circumference", Fig. 2)

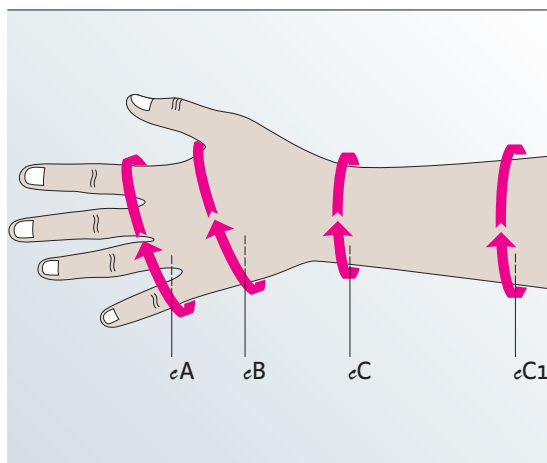

3. Hand circumference

- Hand should be pressed lightly on surface with the back of the hand facing up
- Measure circumference
- Mark the measuring points on the inside of the hand

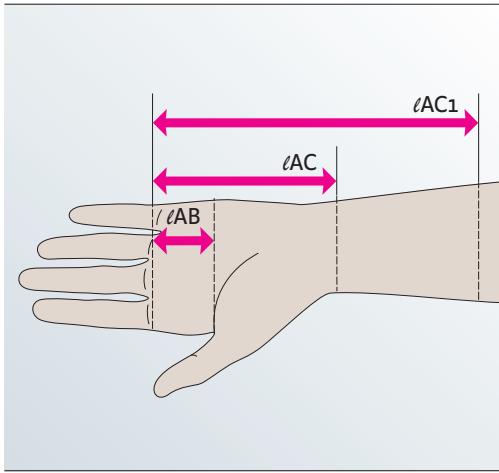

4. Hand length

- Hand is resting lightly on a surface with the palm of the hand facing up
- Length is measured from mark to mark (see "Hand circumference", Fig. 1)

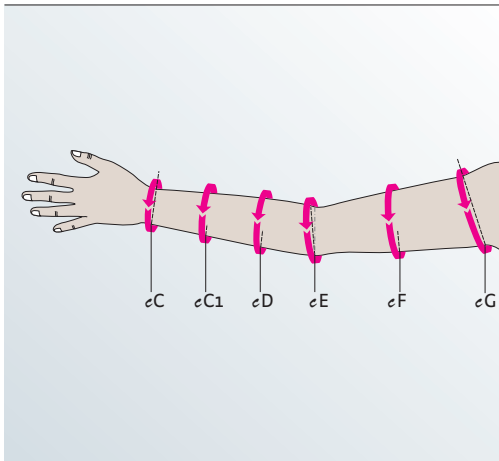

5. Arm circumference

- Lightly rest hand and forearm on a surface
- Measure circumference as shown in drawing
- Mark measuring points for length measurement

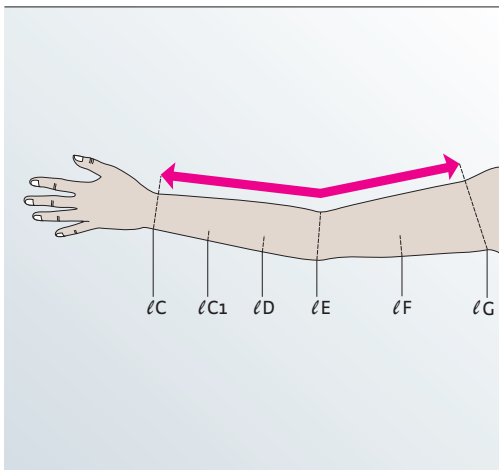

6. Arm length

- Lightly rest hand and forearm on a surface. Arm is extended
- Measure lengths from lC to lC_1 , lC to lD and so on to lG in a line extending back from the groove between the thumb and index finger to the anterior axillary fold, from mark to mark (see circumference dimensions)

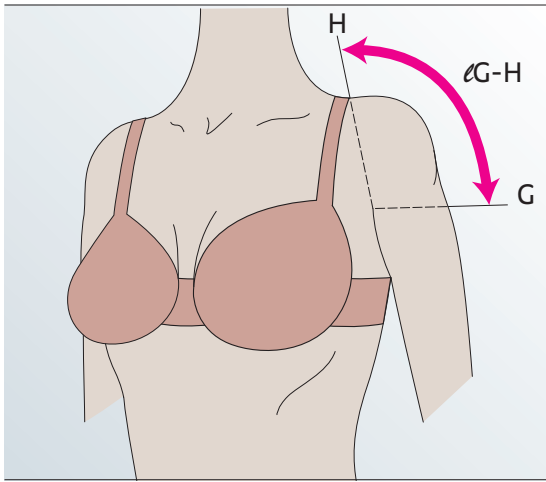

7. Upper arm circumference

For the shoulder cap, measure from point G to H, where H is where the bra strap sits.

Do not measure past point H.

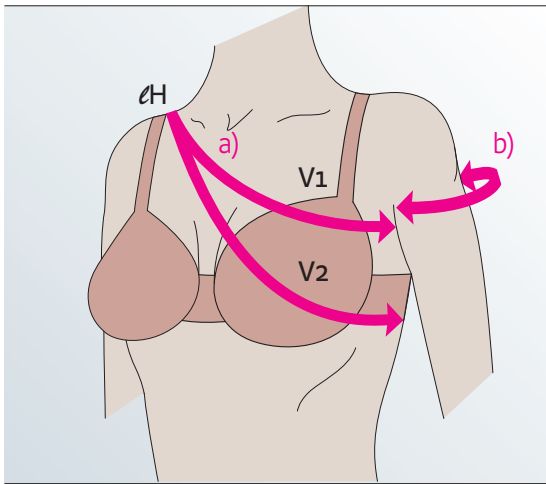

8. Attachments

- a) Shoulder strap
The length of the shoulder is measured according to method 1 or 2 (full circumference)
- b) Anatomical shoulder caps are measured from the anterior to the posterior axillary fold

medi uses the measurement method according to the guidelines of the Federal Academy for Orthopaedic Technology in Dortmund.

circaid[®] inelastic compression – How to measure correctly

- Measure patient's arm length with the arm straight and circumferences when the limb is at its smallest
- Maintain arm size from the time of measuring to ensure a proper fit of the garment

The circaid juxtafit essentials arm length (measured medially) is determined from wrist-to-axilla length provided. A lateral rise is incorporated at the top of the garment in addition to a 10° bend at the elbow. circaid juxtafit essentials arm comes with one circaid cover up (a black cover up will be sent if a color is not selected).

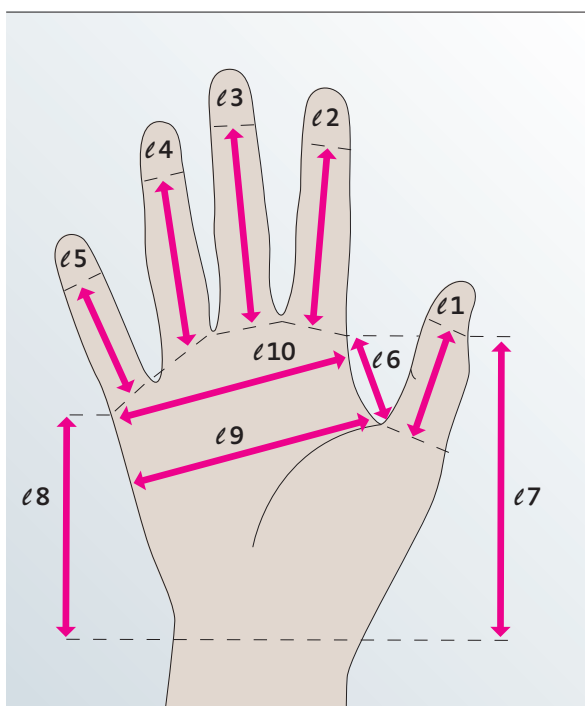

Length Measurements

- **Measurements $l1-l5$**
Length of finger from the center of the crease at base to where the glove should end
- **Measurement $l6$**
Length from base of index finger to the base of thumb webbing
- **Measurement $l7$**
Length from base of index finger (same as $l6$) to base of palm
- **Measurement $l8$**
Length from the crease between the ring finger and pinky finger to the base of the palm
- **Measurement $l9$**
Width of palm at base of thumb webbing
- **Measurement $l10$**
Width of palm at base of pinky finger

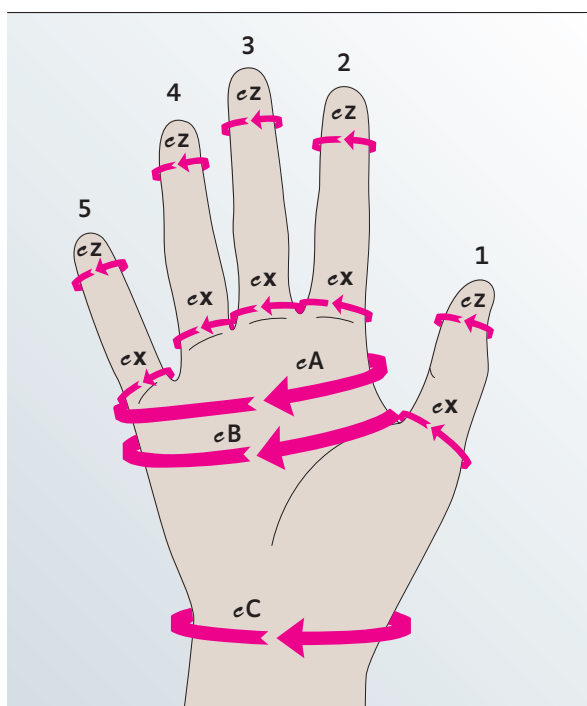

Circumference Measurements

Take measurements without tension

- **Measurements $1eZ-5eZ$**
The circumference where the glove should end; commonly, the Distal Interphalangeal joint (DIP)
- **Measurements $1eX-5eX$**
The circumference of each finger at the Proximal Interphalangeal joint (PIP) or if the base of the finger is larger than the PIP please use the larger measurements
- **Measurement eA**
Circumference of palm at base of pinky
- **Measurement eB**
Circumference of palm at base of thumb webbing
- **Measurement eC**
Circumference of the wrist

- Estimate
- 1st order
- Re-order

Custom Armsleeve & Glove

Telefax: +49 921 912-781, Email: orders@medi.de



Customer name _____ Customer no. _____
 Delivery address _____ Patient name _____
 Delivery date (client) _____ Order date _____ Measured by _____
 Tel no. _____ Email address _____

Stamp / Signature _____

Please take measurements without tension!

Arm measurement Circumferences

Left in cm	Right in cm
	55
	50
	45
	40
	35
	30
	25
	20
	15
	10
	05
	eC Wrist
	eB Palm

Please hold the arm straight.

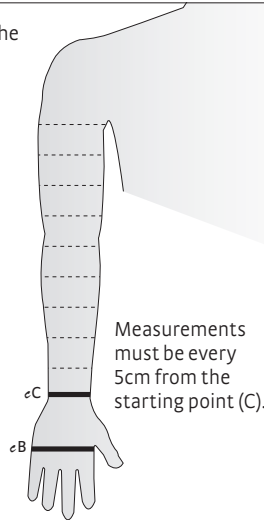

Arm measurement Lengths

Left in cm	Right in cm
<input type="text"/>	<input type="text"/>
<input type="text"/>	<input type="text"/>

Please measure the length on the inside of the arm (from the wrist to elbow crease and from the wrist to axilla).

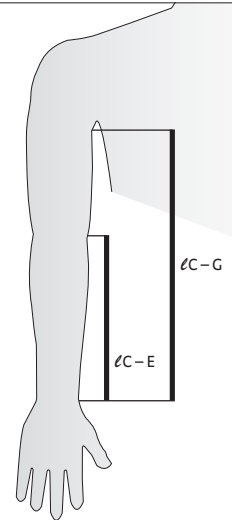

Hand measurement Circumferences

Left in cm	Right in cm
	1eZ
	2eZ
	3eZ
	4eZ
	5eZ
	1eX
	2eX
	3eX
	4eX
	5eX
	eA
	eB Palm
	eC Wrist

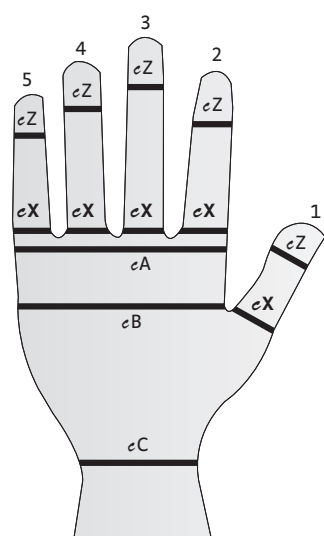

Hand measurement Lengths

Left in cm	Right in cm
	l1
	l2
	l3
	l4
	l5
	l6
	l7
	l8
	l9
	l10

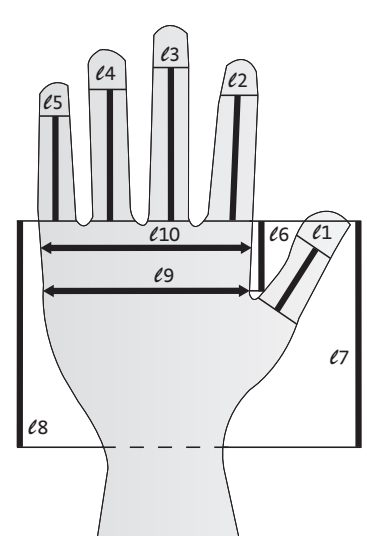

Made-to-measure options

circaid juxtafit essentials arm	Left	Quantity	Right	Quantity
<input type="checkbox"/> armsleeve	<input type="checkbox"/>	_____	<input type="checkbox"/>	_____
<input type="checkbox"/> glove	<input type="checkbox"/>	_____	<input type="checkbox"/>	_____
<input type="checkbox"/> glove with dorsum strap	<input type="checkbox"/>	_____	<input type="checkbox"/>	_____
<input type="checkbox"/> glove with open palm	<input type="checkbox"/>	_____	<input type="checkbox"/>	_____
<input type="checkbox"/> glove with dorsum strap and open palm	<input type="checkbox"/>	_____	<input type="checkbox"/>	_____
<input type="checkbox"/> hand wrap (standard sizes only)	<input type="checkbox"/>	_____	<input type="checkbox"/>	_____
circaid graduate				
<input type="checkbox"/> armsleeve with hand cover	<input type="checkbox"/>	_____	<input type="checkbox"/>	_____

circaid cover up

- Colour options**
- pink
 - beige
 - black

Notes

circaid® juxtafit® essentials arm made-to-measure

circaid® inelastic compression – How to measure correctly

- Patient should be measured when limb is at its smallest
- Patient should be measured in standing position, if possible
- Patient limb should be maintained at time of measuring to ensure a proper fit

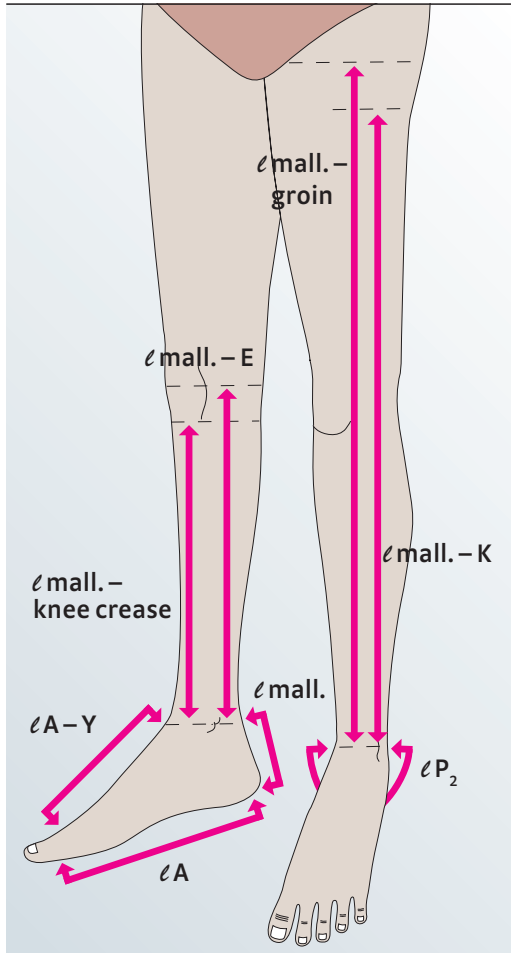

Length Measurements

Measurements start from malleolus

- **Measurement $l_{\text{mall.}} - \text{knee crease}$**
Medial length from the center of the malleolus to the knee crease (measurement $l_{\text{mall.}} - \text{knee crease}$ is where garment will typically begin and end)
- **Measurement $l_{\text{mall.}} - E$**
Lateral length from the center of the malleolus to center of patella
- **Measurement $l_{\text{mall.}} - \text{groin}$**
Medial length from the center of the malleolus to groin, far enough below pubic area so that garment will not cause discomfort (measurement $l_{\text{mall.}} - \text{groin}$ is where garment will typically begin and end)
- **Measurement $l_{\text{mall.}} - K$**
Lateral length from the center of the malleolus to the gluteal fold
- **Measurement $l_{\text{mall.}}$**
Length from floor to the center of the malleolus
- **Measurement l_{A-Y}**
Length from base of great toe to where foot meets ankle
- **Measurement l_A**
Length from base of toes to back of heel
- **Measurement l_{P_2}**
Length from malleolus to malleolus, pass under heel

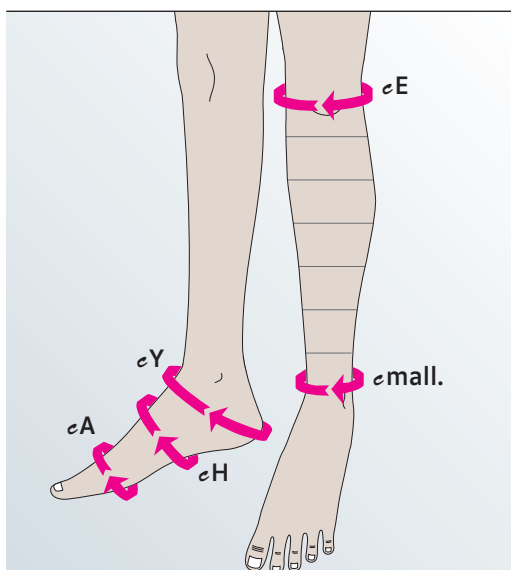

Circumference Measurements

- Take measurements without tension
- Measurements must be taken every 5 cm from the starting point center of malleolus

- **Measurement point $c_{\text{mall.}}$**
Center of the malleolus
- **Measurement point c_E**
Circumference at patella
- **Measurement point c_Y**
Circumference around heel to where foot meets ankle
- **Measurement point c_H**
Arch circumference
- **Measurement point c_A**
Circumference at base of toes

- Estimate
- 1st order
- Re-order

Custom Legging Sizing Form

Telefax: +49 921 912-781, Email: orders@medi.de

medi

Customer name _____ Customer no. _____

Delivery address _____ Patient name _____

Delivery date (client) _____ Order date _____ Measured by _____

Tel no. _____ Email address _____

Stamp / Signature _____

Please take measurements without tension!

Leg measurement Circumferences

Left in cm Right in cm

85	
80	
75	
70	
65	
60	
55	
50	
45	
40	
35	
30	
25	
20	
15	
10	
05	
<i>e</i> mall.	

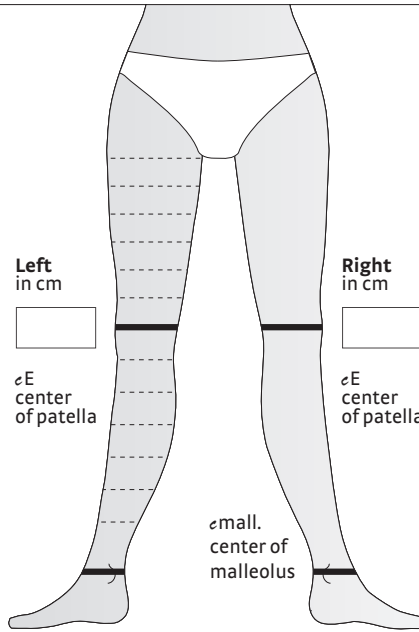

Measurements must be every 5 cm from the starting point center of malleolus.

Leg measurement Lengths

Left in cm Right in cm

*e*mall. - groin

*e*mall. - K

*e*mall. - E

*e*mall. - knee crease

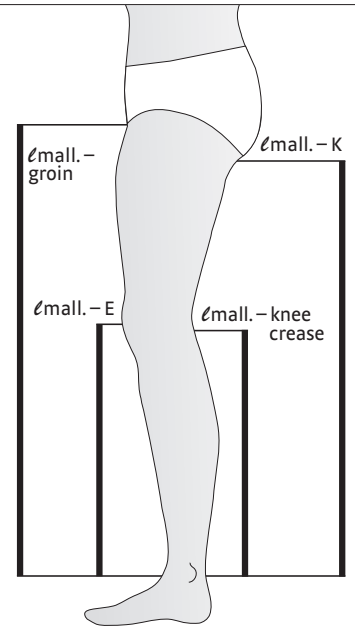

Foot measurement Circumferences

Left in cm Right in cm

*e*mall.

*e*Y

*e*H

*e*A

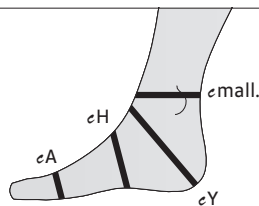

Foot measurement Lengths

Left in cm Right in cm

*e*P₂

*e*mall.

*e*A-Y

*e*A

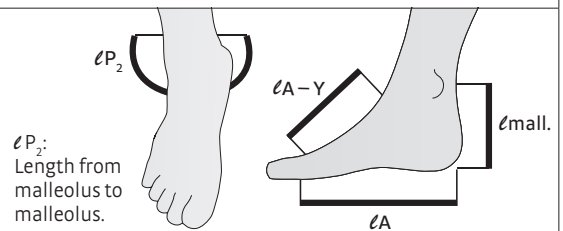

Made-to-measure leg options

circaid juxtafit premium

- lower leg
- lower leg with knee
- knee piece
- upper leg no lateral rise
- upper leg with knee no lateral rise
- whole leg no lateral rise

Left	Quantity	Right	Quantity
<input type="checkbox"/>	_____	<input type="checkbox"/>	_____
<input type="checkbox"/>	_____	<input type="checkbox"/>	_____
<input type="checkbox"/>	_____	<input type="checkbox"/>	_____
<input type="checkbox"/>	_____	<input type="checkbox"/>	_____
<input type="checkbox"/>	_____	<input type="checkbox"/>	_____
<input type="checkbox"/>	_____	<input type="checkbox"/>	_____

Standard foot options (separate only)

- circaid single band afw
- circaid pac band
- circaid juxtafit premium interlocking afw
- circaid juxtafit premium afw

Made-to-measure foot option

circaid juxtafit premium afw

- attached separate

circaid cover up

Colour options

- beige
- black

circaid graduate

- boot only
- lower leg with boot without boot
- whole leg with boot without boot

Notes

circaid® juxtafit® made-to-measure



medi GmbH & Co. KG
Medicusstraße 1
D-95448 Bayreuth / Germany
T +49 921 912-0
F +49 921 912-781
export@medi.de
www.medi.de/en

medi Austria GmbH
Adamgasse 16/7
6020 Innsbruck
Austria
T +43 512 57 95 15
F +43 512 57 95 15 45
vertrieb@medi-austria.at
www.medi-austria.at

medi Belgium bvba
Posthoornstraat 13/1
3582 Koersel
Belgium
T +32 011 24 25 60
F +32 011 24 25 64
info@medibelgium.be
www.medibelgium.be

medi Brasil
Rua Neusa 216
CEP 09941 640
Diadema - Sao Paulo
Brazil
T +55 11 3201 1188
F +55 11 3201 1185
sac@medibrasil.com
www.medibrasil.com

medi Danmark ApS
Vejlegardsvej 59
2665 Vallensbæk Strand
Denmark
T +45 70 25 56 10
F +45 70 25 56 20
kundeservice@sw.dk
www.medit danmark.dk

medi Bayreuth España SL
C/Canigó 2 – 6 bajos
Hospitalet de Llobregat
08901 Barcelona
Spain
T +34 93 260 04 00
F +34 93 260 23 14
medi@mediespana.com
www.mediespana.com

medi France
Z.I. Charles de Gaulle
25, rue Henri Farman
93297 Tremblay en France Cedex
France
T +33 1 48 61 76 10
F +33 1 49 63 33 05
infos@medi-france.com
www.medi-france.com

medi Hungary Kft.
Bokor utca 21
1037 Budapest
Hungary
T +36 1371 0090
F +36 1371 0091
info@medi.hu
www.medi.hu

medi Italia S.r.l.
Via Guido Rossa 28
40033 Casalecchio di Reno-Bologna
Italy
T +39 051 613 24 84
F +39 051 613 29 56
info@medi-italia.it
www.medi-italia.it

medi Medical Support Sdn Bhd
medi representative office Asia
Unit No. B-2-19, Block B, No.2,
Jalan PJU 1A/7A
Oasis Ara Damansara, PJU 1A,
47301 PETALING JAYA
Selangor Darul Ehsan
Malaysia
T +6 03 7832 3591
F +6 03 7832 3921
info@medi-asia.com
www.medi-asia.com

medi Middle East
P. O. Box: 109307
Abu Dhabi
United Arab Emirates
T +971 2 6429201
F +971 2 6429070
info@mediuae.ae
www.mediuae.ae

medi Nederland BV
Heusing 5
4817 ZB Breda
The Netherlands
T +31 76 57 22 555
F +31 76 57 22 565
info@medi.nl
www.medi.nl

medi Norway AS
P.B. 238
4291 Kopervik
Norway
T +47 52 84 45 00
F +47 52 84 45 09
post@medinorway.no
www.medinorway.no

medi Polska Sp. z o. o.
Zygmunta Starego 26
44-100 Gliwice
Poland
T+48 32 230 60 21
F+48 32 202 87 56
info@medi-polska.pl
www.medi-polska.pl

medi Bayreuth Unipessoal, Lda
Rua Eugénio de Castro Rodrigues, nº2
1700-184 Lisboa
Portugal
T +351 21 843 71 60
F +351 21 847 08 33
medi.portugal@medibayreuth.pt
www.medi.pt

medi RUS LRC
Business Park "Rumyantsevo"
Rumyantsevo, Build. 1
Leninsky Township
142784 Moscow Region
Russia
T +7 495 229 04 58
F +7 495 229 04 58
info@medirus.ru
www.medirus.ru

medi Sweden AB
Box 6034
192 06 Sollentuna
Sweden
T +46 8 96 97 98
F +46 8 626 68 70
info@medi.se
www.medi.se

medi UK Ltd.
Plough Lane
Hereford HR4 0EL
United Kingdom
T +44 1432 37 35 00
F +44 1432 37 35 10
enquiries@mediuk.co.uk
www.mediuk.co.uk

medi Ukraine LLC
Tankova Str. 8, office 35
Business-center "Flora Park"
Kiev 04112
Ukraine
T +380 44 591 1163
F +380 44 455 6181
office@medi-ua.com
www.medi-UA.com

medi USA L.P.
6481 Franz Warner Parkway
Whitsett, N.C. 27377-3000
USA
T +1 336 4 49 44 40
F +1 888 5 70 45 54
orders@mediusa.com
www.mediusa.com

Headquarters
medi GmbH & Co. KG
Medicusstraße 1
95448 Bayreuth
Germany
T + 49 921 912-0
F + 49 921 912-781
export@medi.de
www.medi.de/en



97066 / 04.2015